

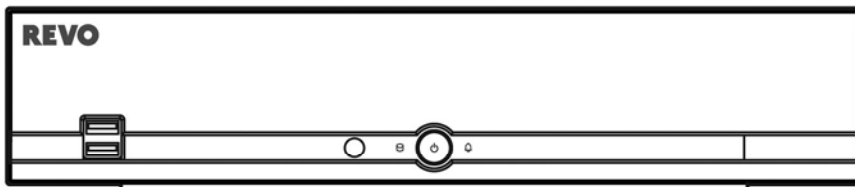

# DIGITAL VIDEO RECORDER

## 4 & 8 Channel USER'S MANUAL



**pentaplex™**  
TECHNOLOGY

REVO's advanced PentaPlex™ technology maximizes the DVR  
by allowing users to View Live Video/Record/Search and  
Playback/Back Up/Access DVR Remotely – ALL AT THE SAME TIME!



www.revoamerica.com  
1-866-625-REVO (7386)





## WARNING

RISK OF ELECTRIC SHOCK  
DO NOT OPEN



**WARNING:** TO REDUCE THE RISK OF ELECTRIC SHOCK,  
DO NOT REMOVE COVER (OR BACK).  
NO USER-SERVICEABLE PARTS INSIDE.  
REFER SERVICING TO QUALIFIED  
SERVICE PERSONNEL.



The lightning flash with arrowhead symbol, within an equilateral triangle, is intended to alert the user to the presence of uninsulated "dangerous voltage" within the product's enclosure that may be of sufficient magnitude to constitute a risk of electric shock.



The exclamation point within an equilateral triangle is intended to alert the user to the presence of important operating and maintenance (servicing) instructions in the literature accompanying the appliance.

### COMPLIANCE NOTICE OF FCC:

THIS EQUIPMENT HAS BEEN TESTED AND FOUND TO COMPLY WITH THE LIMITS FOR A CLASS A DIGITAL DEVICE, PURSUANT TO PART 15 OF THE FCC RULES. THESE LIMITS ARE DESIGNED TO PROVIDE REASONABLE PROTECTION AGAINST HARMFUL INTERFERENCE WHEN THE EQUIPMENT IS OPERATED IN A COMMERCIAL ENVIRONMENT. THIS EQUIPMENT GENERATES, USES, AND CAN RADIATE RADIO FREQUENCY ENERGY AND IF NOT INSTALLED AND USED IN ACCORDANCE WITH THE INSTRUCTION MANUAL, MAY CAUSE HARMFUL INTERFERENCE TO RADIO COMMUNICATIONS. OPERATION OF THIS EQUIPMENT IN A RESIDENTIAL AREA IS LIKELY TO CAUSE HARMFUL INTERFERENCE, IN WHICH CASE USERS WILL BE REQUIRED TO CORRECT THE INTERFERENCE AT THEIR OWN EXPENSE.

**WARNING:** CHANGES OR MODIFICATIONS NOT EXPRESSLY APPROVED BY THE PARTY RESPONSIBLE FOR COMPLIANCE COULD VOID THE USER'S AUTHORITY TO OPERATE THE EQUIPMENT.

THIS CLASS OF DIGITAL APPARATUS MEETS ALL REQUIREMENTS OF THE CANADIAN INTERFERENCE-CAUSING EQUIPMENT REGULATIONS.

The information in this manual is believed to be accurate as of the date of publication. We are not responsible for any problems resulting from the use thereof. The information contained herein is subject to change without notice. Revisions or new editions to this publication may be issued to incorporate such changes.

The software included in this product contains some Open Sources. You may obtain the complete corresponding source code from us. See the Open Source Guide on the software CD (*OpenSourceGuide\OpenSourceGuide.pdf*) or as a printed document included along with the User's Manual.

## Important Safeguards

|   |  |
|---|--|
| <p><b>1. Read Instructions</b><br/>All the safety and operating instructions should be read before the appliance is operated.</p> <p><b>2. Retain Instructions</b><br/>The safety and operating instructions should be retained for future reference.</p> <p><b>3. Cleaning</b><br/>Unplug this equipment from the wall outlet before cleaning it. Do not use liquid aerosol cleaners. Use a damp soft cloth for cleaning.</p> <p><b>4. Attachments</b><br/>Never add any attachments and/or equipment without the approval of the manufacturer as such additions may result in the risk of fire, electric shock or other personal injury.</p> <p><b>5. Water and/or Moisture</b><br/>Do not use this equipment near water or in contact with water.</p> <p><b>6. Placement and Accessories</b><br/>Do not place this equipment on an unstable cart, stand or table. The equipment may fall, causing serious injury to a child or adult, and serious damage to the equipment.</p> <div style="text-align: center;">  </div> <p>This equipment and cart combination should be moved with care. Quick stops, excessive force, and uneven surfaces may cause the equipment and cart combination to overturn.</p> <p>Do not place this equipment in a closed space. Sufficient amount of ventilation air is necessary to avoid increase of ambient temperature which can cause improper operation or the risk of fire.</p> <p><b>7. Power Sources</b><br/>This equipment should be operated only from the type of power source indicated on the marking label. If you are not sure of the type of power, please consult your equipment dealer or local power company.</p> <p><b>8. Power Cords</b><br/>Operator or installer must remove power and TNV connections before handling the equipment.</p> <p><b>9. Lightning</b><br/>For added protection for this equipment during a lightning storm, or when it is left unattended and unused for long periods of time, unplug it from the wall outlet and disconnect the antenna or cable system. This will prevent damage to the equipment due to lightning and power-line surges.</p> | <p><b>10. Overloading</b><br/>Do not overload wall outlets and extension cords as this can result in the risk of fire or electric shock.</p> <p><b>11. Objects and Liquids</b><br/>Never push objects of any kind through openings of this equipment as they may touch dangerous voltage points or short out parts that could result in a fire or electric shock. Never spill liquid of any kind on the equipment.</p> <p><b>12. Servicing</b><br/>Do not attempt to service this equipment yourself. Refer all servicing to qualified service personnel.</p> <p><b>13. Damage requiring Service</b><br/>Unplug this equipment from the wall outlet and refer servicing to qualified service personnel under the following conditions:</p> <ul style="list-style-type: none"> <li>A. When the power-supply cord or the plug has been damaged.</li> <li>B. If liquid is spilled, or objects have fallen into the equipment.</li> <li>C. If the equipment has been exposed to rain or water.</li> <li>D. If the equipment does not operate normally by following the operating instructions, adjust only those controls that are covered by the operating instructions as an improper adjustment of other controls may result in damage and will often require extensive work by a qualified technician to restore the equipment to its normal operation.</li> <li>E. If the equipment has been dropped, or the cabinet damaged.</li> <li>F. When the equipment exhibits a distinct change in performance – this indicates a need for service.</li> </ul> <p><b>14. Replacement Parts</b><br/>When replacement parts are required, be sure the service technician has used replacement parts specified by the manufacturer or that have the same characteristics as the original part. Unauthorized substitutions may result in fire, electric shock or other hazards.</p> <p><b>15. Safety Check</b><br/>Upon completion of any service or repairs to this equipment, ask the service technician to perform safety checks to determine that the equipment is in proper operating condition.</p> <p><b>16. Field Installation</b><br/>This installation should be made by a qualified service person and should conform to all local codes.</p> <p><b>17. Correct Batteries</b><br/>Warning: Risk of explosion if battery is replaced by an incorrect type. Dispose of used batteries according to the instructions.</p> <p><b>18. Tmra</b><br/>A manufacturer's maximum recommended ambient temperature (Tmra) for the equipment must be specified so that the customer and installer may determine a suitable maximum operating environment for the equipment.</p> |
|---|--|

## WEEE (Waste Electrical & Electronic Equipment)

### Correct Disposal of This Product

*(Applicable in the European Union and other European countries with separate collection systems)*



This marking shown on the product or its literature, indicates that it should not be disposed with other household wastes at the end of its working life. To prevent possible harm to the environment or human health from uncontrolled waste disposal, please separate this from other types of wastes and recycle it responsibly to promote the sustainable reuse of material resources.

Household users should contact either the retailer where they purchased this product, or their local government office, for details of where and how they can take this item for environmentally safe recycling.

Business users should contact their supplier and check the terms and conditions of the purchase contract. This product should not be mixed with other commercial wastes for disposal.

## Table of Contents

|  |    |
|--|----|
| Chapter 1 — Introduction .....                 | 1  |
| Features .....                                 | 1  |
| Package Contents .....                         | 2  |
| Chapter 2 — Installation & Configuration ..... | 3  |
| Rear Panel Connectors .....                    | 3  |
| Front Panel Controls .....                     | 5  |
| Infrared Remote Control .....                  | 6  |
| Turning on the Power .....                     | 8  |
| Quick Setup Wizard .....                       | 9  |
| Advanced Setup .....                           | 13 |
| System Setup .....                             | 14 |
| Network Setup .....                            | 16 |
| Camera Setup .....                             | 21 |
| Record Setup .....                             | 21 |
| Event Setup .....                              | 23 |
| Display Setup .....                            | 26 |
| Chapter 3 — Operation .....                    | 29 |
| Live Monitoring .....                          | 29 |
| Display Menu .....                             | 31 |
| Event Monitoring .....                         | 32 |
| Active Cameo Mode .....                        | 32 |
| PTZ Mode .....                                 | 32 |
| Recording Video .....                          | 33 |
| Playing Recorded Video .....                   | 34 |
| Searching Video .....                          | 34 |
| Search .....                                   | 36 |
| Go To .....                                    | 39 |
| Export .....                                   | 39 |
| REVO Remote .....                              | 40 |
| Web Monitoring .....                           | 41 |
| Web Search .....                               | 43 |
| Appendix .....                                 | 45 |
| Error Code Notices .....                       | 45 |
| Troubleshooting .....                          | 45 |
| Map of Screens (Advanced Setup) .....          | 46 |
| Specifications .....                           | 47 |
| Index .....                                    | 49 |



# Chapter 1 — Introduction

## FEATURES

Your color digital video recorder (DVR) provides recording capabilities for four or eight camera inputs. It provides exceptional picture quality in both live and playback modes, and offers the following features:

- 4 or 8 RJ-12 Input Connectors
- Compatible with Color (NTSC) and B&W (CCIR and EIA-170) Video Sources
- Records up to 240 NTSC Images per Second
- Continuous Recording in Disk Recycle Mode
- Records while Playing Back and Transmitting to Remote Site
- Full Function Infrared Remote Control
- User-friendly Graphical User Interface (GUI) Menu System
- Multiple Recording Modes (Time-lapse, Pre-event, Motion, Alarm and Panic)
- Multiple Search Engines (Date/Time, Event, Record Table)
- Audio Monitoring Capable
- 4- or 8-Channel Audio Recording and 1-Channel Audio Playback
- Alarm Connections Include: Input and Output
- 2 USB 2.0 Ports
- Built-in Buzzer
- Live or Recorded Video Access via Ethernet
- Self-diagnostics with Automatic Notification including Hard Disk Drive S.M.A.R.T. Protocol

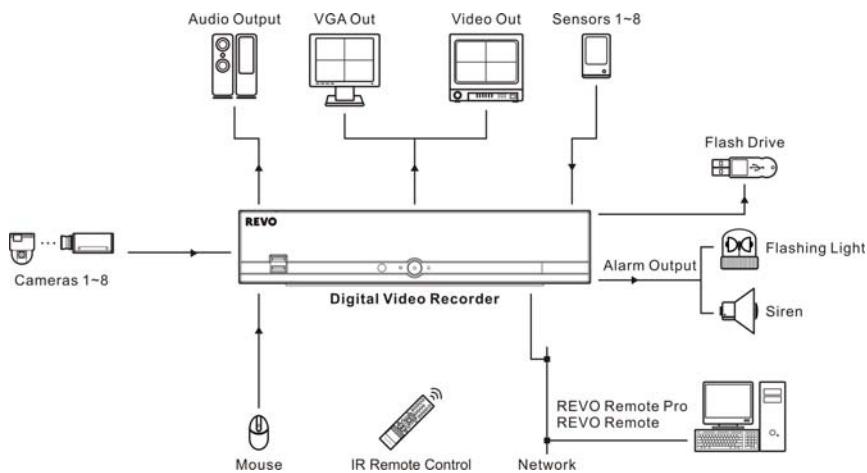

Typical DVR installation

**NOTE:** This manual covers the 4- and 8-channel digital video recorders. The DVRs are identical except for the number and type of cameras and alarms that can be connected and the number of cameras that can be displayed. For simplicity, the illustrations and descriptions in this manual refer to the 8-camera model.

## PACKAGE CONTENTS

The package contains the following:

- Digital Video Recorder
- Power Adaptors and Power Cords (DVR, Camera)
- USB Mouse
- Infrared Remote Control and Batteries
- REVO Remote Pro Software CD and User's Manual (This document)

**NOTE: The adaptor and power cord for camera are only for the 8-channel DVR.**



Digital Video Recorder



Power Adaptors



Power Cords



USB Mouse

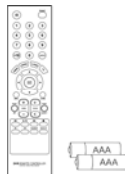

IR Remote Control and Batteries (AAA Type)



REVO Remote Pro Software CD and User's Manual



# Chapter 2 — Installation & Configuration

## REAR PANEL CONNECTORS

No special tools are required to install the DVR. Refer to the installation manuals for the other components that make up part of your system. Your DVR should be completely installed before proceeding.

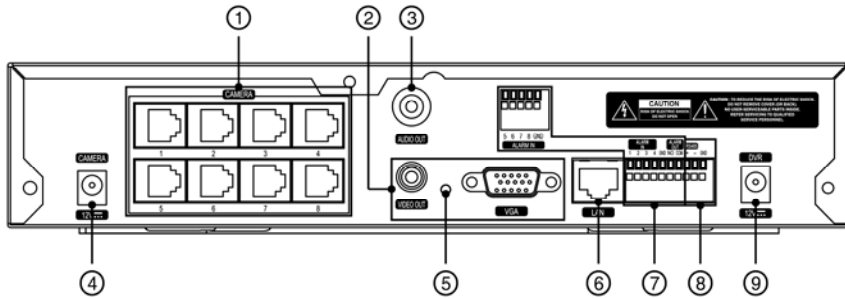

8-Channel Model

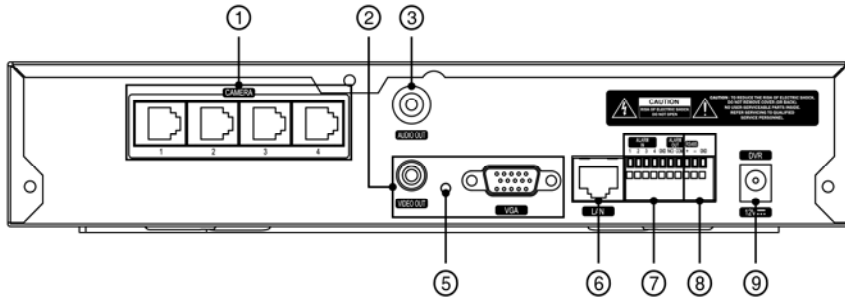

4-Channel Model

- ① Video In
- ② Video Out
- ③ Audio Out
- ④ Camera Power Connector
- ⑤ Factory Reset Switch
- ⑥ Network Port
- ⑦ Alarm Input/Output
- ⑧ RS-485 Port
- ⑨ DVR Power Connector

### Connecting the Video Input

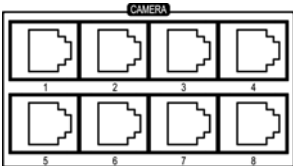

Connect the RJ-12 cables from the observation cameras to the modular RJ-12 connectors.

### Connecting the Monitor



If you prefer to use a standard CCTV monitor, connect it to the Video Out connector using the RCA jack.



A VGA connector is provided so that you can use a standard, multi-sync computer monitor as your main monitor. Use the cable supplied with your monitor to connect it to the DVR. The VGA monitor is automatically detected when you connect it.

**NOTE:** The DVR supports simultaneous operation of a CCTV and a VGA monitor.

### Connecting Audio

**NOTE:** It is the user's responsibility to determine if local laws and regulations permit recording audio.



Connect Audio Out to your amplifier using the RCA jack. Connect the audio sources to the audio input connector of the observation cameras that are connected to the modular RJ-12 connectors of the DVR. Refer to the observation camera manual for configuring the Audio In connection. Your DVR can record audio from up to eight sources.

### Connecting the Observation Camera Power Cord



The CAMERA power connector is provided to supply power to the observation cameras. (8-ch model only) Connect the connector of the adaptor to the DVR, and connect the AC power cord to the adaptor and then to the wall outlet.

### Factory Reset



The DVR has a Factory Reset switch to the left of the VGA port on the rear panel. This switch will only be used on the rare occasions that you want to return all the settings to the original factory settings.



**CAUTION:** When using the *Factory Reset*, you will lose any settings you have saved.

To reset the unit, you will need a straightened paperclip:

Turn the DVR off. → Poke the straightened paperclip in the unlabeled hole to the left of the VGA port, and turn the DVR on. → Hold the switch until the DVR turns on and the live monitoring screen appears. → Release the reset switch. All of the DVR's settings are now at the original settings it had when it left the factory.

### Network Port



The DVR can be networked using the 10/100Mb Ethernet connector. Connect a Cat5 cable with an RJ-45 jack to the DVR connector. The DVR can be networked with a computer for remote monitoring, searching, configuration and software upgrades. See the *Network Setup* section in this chapter for configuring the Ethernet connections.



**CAUTION:** The network connector is not designed to be connected directly with cable or wire intended for outdoor use.

### Connecting Alarms

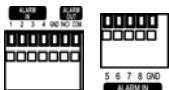

**NOTE:** To make connections on the Alarm Connector Strip, press and hold the button and insert the wire in the hole below the button. After releasing the button, tug gently on the wire to make certain it is connected. To disconnect a wire, press and hold the button above the wire and pull out the wire.

**Alarm In 1 to 8:** You can use external devices to signal the DVR to react to events. Mechanical or electrical switches can be wired to the ALARM IN and GND (Ground) connectors. The threshold voltage for NC (Normally Closed) is above 4.3V and for NO (Normally Open) is below 0.3V, and it should be stable at least 0.5 seconds to be detected.

**GND (Ground):** Connect the ground side of the alarm input and/or alarm output to a GND connector.

**NOTE:** All the connectors marked GND are common.

**NO (Relay Alarm Output):** Connect the device to the COM and NO (Normally Open) connector. NO is a relay output which sinks 1A@30VDC (NO).

Connector Pin Outs:

|                   |                           |
|-------------------|---------------------------|
| Alarm In (1 to 8) | Alarm Inputs 1 to 8       |
| GND               | Chassis Ground            |
| NO                | Alarm Out (Normally Open) |
| COM               | Common                    |

## Connecting to the RS-485 Port



The RS-485 connector can be used to control PTZ (pan, tilt, zoom) cameras. Connect TX+/RX+ or TX-/RX- of the control system to the + or - (respectively) of the DVR. See the *Camera Setup* section in this chapter of this manual and the PTZ camera manufacturer's manual for configuring the RS-485 connection.

Connector Pin Outs:

| Master Unit |        | Slave Unit |  |
|-------------|--------|------------|--|
| +           | → To → | TX+/RX+    |  |
| -           | → To → | TX-/RX-    |  |
| GND         | → To → | GND        |  |

## Connecting the DVR Power Cord



Connect the connector of the adaptor to the DVR, and connect the AC power cord to the adaptor and then to the wall outlet.



**WARNING: ROUTE POWER CORDS SO THAT THEY ARE NOT A TRIPPING HAZARD. MAKE CERTAIN THE POWER CORD WILL NOT BE PINCHED OR ABRADED BY FURNITURE. DO NOT INSTALL POWER CORDS UNDER RUGS OR CARPET. THE POWER CORD HAS A GROUNDING PIN. IF YOUR POWER OUTLET DOES NOT HAVE A GROUNDING PIN RECEPTACLE, DO NOT MODIFY THE PLUG. DO NOT OVERLOAD THE CIRCUIT BY PLUGGING TOO MANY DEVICES IN TO ONE CIRCUIT.**



**CAUTION:** Ensure the DVR is not near any heat source that could cause overheating.



**CAUTION:** The DVR does not have an internal fan so leave a clearance of at least 6 inches near ventilation hole areas on each side panel of the unit for proper ventilation.

## FRONT PANEL CONTROLS

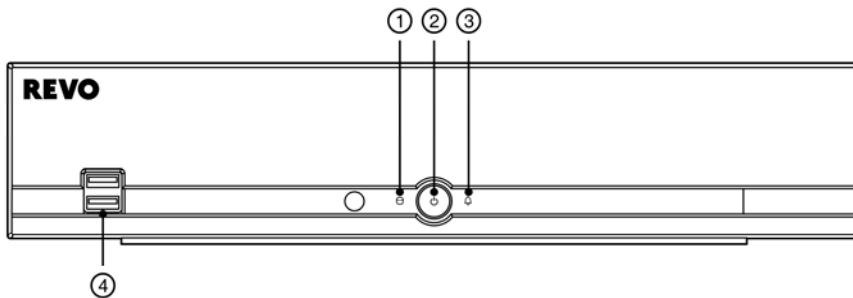

① HDD LED

② Power LED

③ Alarm LED

④ USB Port

**NOTE:** The infrared sensor on the DVR is just to the left of the HDD LED. Make certain that nothing blocks the sensor, or the remote control will not function properly.

**NOTE:** When you use wireless communication devices (such as Wi-Fi or Bluetooth) near the DVR, the remote control might not function properly.

### HDD LED

The HDD LED flickers when the DVR is recording or searching video on the hard disk drive.

### Power LED

The power LED is lit when the unit is On.

### Alarm LED

The Alarm LED is lit when alarm output or internal buzzer is activated.

### USB Port

Connect the supplied USB mouse to one of the ports. The USB mouse will be used to access many of the DVR's functions. A USB flash drive can be connected for backup or system upgrades.

## INFRARED REMOTE CONTROL

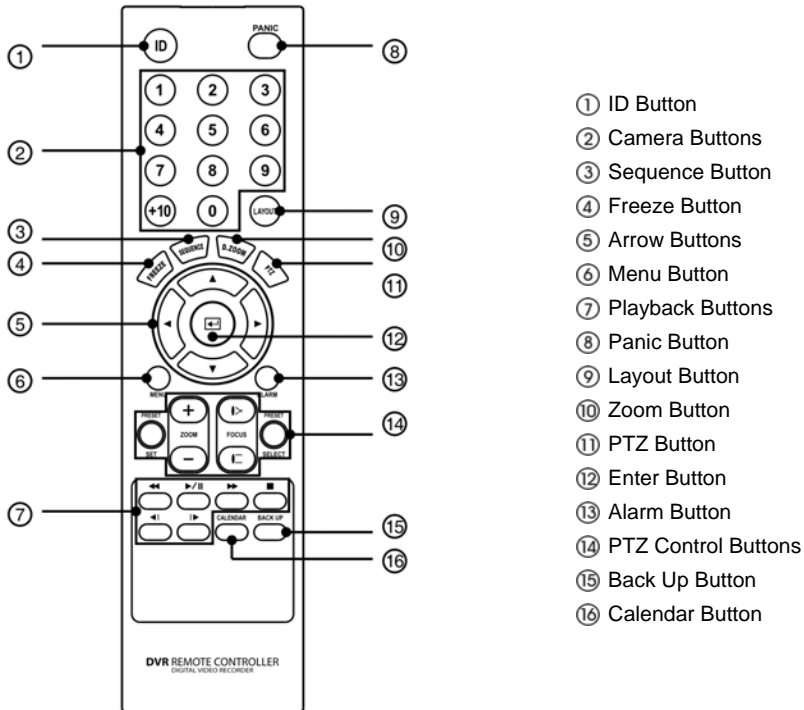

### ID Button

If a DVR System ID is set to 0, the infrared remote control will control that DVR without any additional entries. (Refer to the *Advanced Setup* section in this chapter for further information on setting the System ID.) If the DVR system ID is 1 to 16, you must press the ID button on the remote control followed by the number button (1 to 16 (+10 & 6)) in order to control that DVR. If two or more DVRs have the same ID, those DVRs will react to the infrared remote control at the same time.

## CAMERA Buttons

Pressing the individual camera buttons will cause the selected camera to display full screen. Buttons 1 to 9 are also used to enter passwords.

## SEQUENCE Button

When in the Live Monitoring mode, pressing the SEQUENCE button displays live channels sequentially.

## FREEZE Button

Pressing the FREEZE button freezes the current live screen.

## Up, Down, Left, Right Arrow Buttons

These buttons are used to navigate through menus and items displayed in the Live Monitoring or Search screens. They are also used to navigate through menus and GUI during the system setup. You also can use them to change numbers by highlighting a number in a menu and using the Up and Down arrow buttons to increase or decrease the number's value.

The arrow buttons are also used to control Pan and Tilt when in the PTZ mode.















When in the PIP display format, pressing the Up and Down arrow buttons moves the position of the small screen counter-clockwise and clockwise.

Pressing the Left and Right buttons moves through screen pages in the Live Monitoring mode and Search mode.

## MENU Button

In the Live Monitoring mode and Search mode, pressing the MENU button displays the menu icons at the top of the screen. Pressing the button also hides the menu icons. During menu setup, pressing the button closes the current menu or setup dialog box.

## Playback Buttons

- **Rewind:** Pressing the  button plays video backward at high speed. Pressing the button again toggles the playback speed from ,  and .
- **Play/Pause:** Pressing the  button plays back video at regular speed. The screen displays  when the DVR is in the Pause mode and the screen displays  when the DVR is playing back video.
- **Fast Forward:** Pressing the  button plays video forward at high speed. Pressing the button again toggles the playback speed from ,  and .
- **Stop:** Pressing the  button stops playback and enters the Live Monitoring mode.
- **Backward:** When in the pause mode, pressing the  button moves to the previous image.
- **Forward:** When in the pause mode, pressing the  button moves to the next image.

In the Live Monitoring mode, pressing any playback button enters to the Search mode.

## PANIC Button

Pressing the PANIC button starts panic recording of all camera channels, and displays  on the screen. Pressing the button again will stop panic recording.

## LAYOUT Button

Pressing the LAYOUT button toggles between different display formats. The available formats are: 3x3, 2x2 and PIP.

## ZOOM Button

Pressing the ZOOM button zooms the current image on the screen. A PIP with a rectangle temporarily displays showing what area of the screen has been enlarged. You can use the arrow buttons to move the rectangle to another area.

## PTZ Button

Pressing the PTZ button enters the PTZ (Pan/Tilt/Zoom) mode which allows you to control properly configured cameras.

## Enter Button

The  (Enter) button selects a highlighted item or completes an entry that you have made during system setup. This button is also used to enter the Cameo mode in the Live Monitoring mode or Search mode (8-ch model only).

## ALARM Button

Pressing the ALARM button resets the DVR's outputs including the internal buzzer during an alarm.

## PTZ Control Buttons

While in the PTZ mode, the PRESET buttons are used to save Presets and load a Preset View, the ZOOM buttons are used to Zoom In and Zoom Out, and the FOCUS buttons are used for Near Focus and Far Focus.

## BACK UP Button

Pressing the BACK UP button allows you to copy video clips.

## CALENDAR Button

In the search mode, pressing the CALENDAR button displays the Calendar Search screen.

# TURNING ON THE POWER

Connecting the power cord to the DVR turns on the unit. The unit will take approximately 30 seconds to initialize.







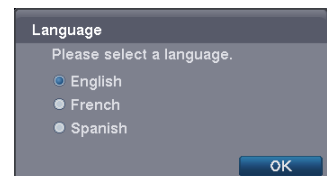





As soon as the DVR's initialization process completes, you might have the DVR's internal buzzer sound if not all cameras (8 and 4 cameras for 8- and 4-channel DVR respectively) are installed to the DVR because the DVR is set to use all camera channels by default. To turn the internal buzzer off, press the ALARM button on the remote control, or move the mouse pointer to the top of the screen and click the  (Alarm) icon.

When you turn the system on for the first time, you will be asked to select the startup language. Select the desired language and then click the OK button.

**NOTE:** You can change the language during System setup. Refer to the *Advanced Setup* section of this chapter.







Before using your DVR for the first time, you will want to establish the initial settings. The following describes how to use the remote control and mouse in the setup screen. Take a minute to review the descriptions.

|                              | Remote Control   | Mouse   |
|------------------------------|--|---|
| To enter the setup screen... | In Live Monitoring mode, press the MENU button to display the menu icons at the top of the screen. Select the  (Setup) icon by pressing the  .   | In the Live Monitoring mode, move the mouse pointer to the top of the screen to display hidden menu icons. Click the  (Setup) icon with the left button. |
| To select items...           | Move to the desired item by pressing the arrow buttons (     ) and select it by pressing the  . | Click the desired item with the left button.  |
| To change values...          | Select the desired item and press the Up and Down arrow buttons (   ) to increase or decrease the values and then press the  button to complete the entry.  | Select the desired item with the left button and roll the mouse wheel up and down to increase or decrease the values.   |
| To enter characters...       | Select the desired item and press the  button to displays a virtual keyboard. Move to the desired character by pressing the arrow buttons, and press the  .  | Select the desired item with the left button to displays a virtual keyboard. Click the desired character with the left button.  |

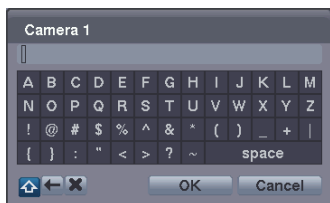
**NOTE:** For simplicity, most of the operation explanations in this manual are based on using the Remote Control.

While setting up the DVR, there will be many opportunities to enter names and titles. When making these entries, a Virtual Keyboard will appear.



Use the arrow buttons on the remote control to highlight the character you want in the name or title and press the  button. That character appears in the title bar and the cursor moves to the next position. Selecting  toggles between the upper and lower case keyboards,  backspaces, and  deletes entered characters. You can use up to 31 characters including spaces in your title.

## QUICK SETUP WIZARD

When you turn the system on for the first time, the Quick Setup Wizard will run. The Quick Setup Wizard guides you through configuring the system for basic operation. The wizard also can be accessed by selecting Quick Setup in the Main Setup screen. Refer to the following *Advanced Setup* section.



Select the Next button to start the Quick Setup Wizard.

**NOTE:** Selecting the **Cancel** button throughout the screens exits the Quick Setup Wizard without saving your changes and return to the Live Monitoring mode.

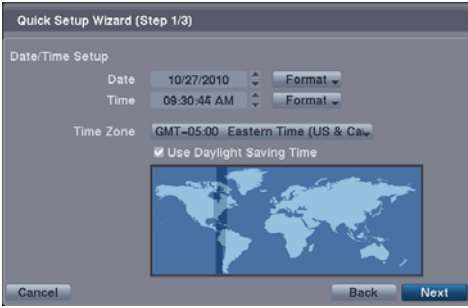

Date/Time Setup

- **Date:** Set the system date and select the date format.
- **Time:** Set the system time and select the time format.
- **Time Zone:** Select your time zone. The Time Zone can be selected on the map.
- **Use Daylight Saving Time:** Selecting the box sets the system to use daylight saving time.

**NOTE: The Date/Time will be set, and the clock will start when you click the Next button.**



Record Method Setup

- Select the desired recording mode from:
  - Motion Event Record (Recommended)
  - Continuous & Motion Event Record
  - Continuous Record

**NOTE: You should understand each recording mode before setting the DVR's recording method.**



Record Video Quality Setup

- Select the desired video quality profile from:
  - Higher Video Quality Priority Profile
  - Standard Recording Profile
  - Longer Recording Time Priority Profile

**NOTE: The higher quality setting requires more storage space.**

**NOTE: The recording resolution will be set to Very High when selecting *High Video Quality Priority Profile*, High (Very High for Post-Event Record) when selecting *Standard Recording Profile*, and Standard (High for Post-Event Record) when selecting *Longer Recording Time Priority Profile*.**

**NOTE: The recording quality and recording speed of each camera channel will be set as shown below according to the Record Method and Record Video Quality you set.**

|                                  | HVQPP*   | SRP*   | LRTPP*   |
|----------------------------------|--|--|--|
| Motion Event Record              | Very High / 30 ips   | High / 5 ips   | Standard / 2.5 ips                                     |
| Continuous & Motion Event Record | Very High / 30 ips (Time)<br>Very High / 30 ips (Post-Event) | High / 5 ips (Time)<br>Very High / 30 ips (Post-Event) | Standard / 2.5 ips (Time)<br>High / 5 ips (Post-Event) |
| Continuous Record                | Very High / 30 ips   | High / 5 ips (Time)                                    | Standard / 2.5 ips                                     |

\* Record Video Quality: HVQPP (High Video Quality Priority Profile), SRP (High Video Quality Priority Profile), LRTPP (Longer Recording Time Priority Profile)



Select the Finish button to finish the Quick Setup Wizard and start the Network Setup.





Select the Next button to start the Network Setup Wizard.

**NOTE: The Network wizard also can be accessed by selecting *Network Setup* in the Main Setup screen. Refer to the following *Advanced Setup* section.**



### Internet Connection

Select whether or not your DVR is connected to the Internet.



### LAN Setup

Select between Auto Configuration and Manual Configuration for network configuration, and then select the Test button to test the network configuration you selected.

**NOTE: Selecting *Auto Configuration* allows the DVR to automatically obtain LAN parameters (IP address, Gateway, Subnet Mask and DNS Server address). Selecting *Manual Configuration* allows you to set up LAN parameters manually.**

**NOTE: The network configuration you set should be tested by selecting *Test*, otherwise the *Next* button will not be selected, and you cannot move to the next step.**

- Use DSL/PPPoE Setup: Selecting the box allows you to set up the DSL network. Entering the ID and password for DSL connection is required.



### REVO EZLink Setup

- DVR Name: Enter the DVR name to be registered on the DVRNS (DVR Name Service) server.
- Test: Select the box to check whether or not the name you entered can be used and test whether or not the REVO EZLink Service is working properly.

**NOTE: The DVR name you entered should be checked by selecting *Test*, otherwise the REVO EZLink Service changes will not be saved.**

**NOTE: When entering no name or a name already registered on the DVRNS server, an error message displays.**

**NOTE: Blackberry devices do not support the REVO EZLink service.**



### REVO Dashboard Setup I

Select the Next button to start the Dashboard Setup.

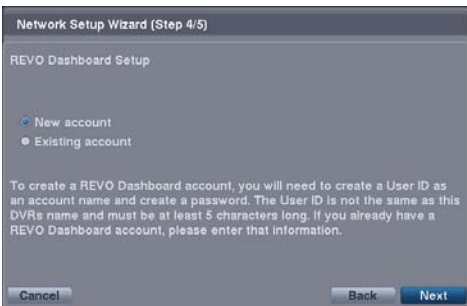

### REVO Dashboard Setup II

Select New account if you want to create a new Dashboard account, and select Existing account if you want to use your existing Dashboard account.



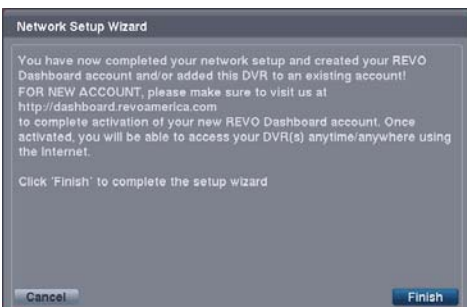

### REVO Dashboard Setup III

Enter the User ID and Password for your Dashboard account. And then register the DVR you want to access by entering the DVR name and selecting the Register/Add a new DVR button.



Select the Finish button to finish the Setup Wizard.

## ADVANCED SETUP

To enter the Main Setup screen, press the MENU button on the remote control. Select the  (Setup) icon at the top of the screen by pressing the  button. The Login screen appears.

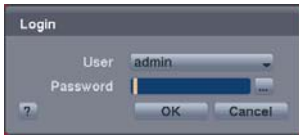

Select a User and enter the password by pressing the appropriate combination of Camera number buttons on the remote control and select the OK button. The factory default password is 1234 for a User and there is no password for an admin user. If you do not know the password, click the  button for guidance.

**NOTE:** When logged on as the User, live monitoring, searching video and exporting recorded data (Backup) can only be allowed.





**NOTE:** Setting up a password is strongly recommended to ensure secure management of the system.

**NOTE:** To enter a password by using the mouse, click the , and a virtual keyboard displays. See instructions above for using the virtual keyboard.



**NOTE:** Selecting *Quick Setup* or *Network Setup* in the Main Setup screen runs the selected setup wizard. Refer to the previous *Quick Setup Wizard* section for information regarding the Quick Setup and Network Setup.

Selecting *Advanced Setup* in the Main Setup screen displays the following Advanced Setup screen, and gives you to access to all the DVR's setup screens. Your DVR can be set up using various screens and dialog boxes.

Throughout the screens you will see . Selecting the  and pressing the  button on the remote control gives you the opportunity to reset that screen to its default settings. You can save your changes by selecting the Save button and pressing the  button. Selecting the Cancel button exits the screen without saving the changes.



- ① System Menu
- ② Network Menu
- ③ Camera Menu
- ④ Record Menu
- ⑤ Event Menu
- ⑥ Display Menu

**NOTE:** When the installed hard disk drive is not formatted, a message box appears asking you to format the hard disk drive. If you want to record video, you must format the hard disk drive.

## SYSTEM SETUP

### System Settings (SYSTEM → System Tab)



- **System ID:** Set the system ID. Use the Up and Down arrow buttons or scroll the mouse wheel to increase or decrease the number.

**NOTE:** It is possible to have multiple DVRs with the same System ID in the same area. In this case, all DVRs with the same System ID will be controlled at the same time when using the infrared remote control for that ID number.

- **Language:** Select the desired language.

- **Version:** Displays the software version of the DVR. To upgrade the software, connect a USB flash drive containing the upgrade package file (.rui) to the DVR. Selecting Upgrade... displays the Upgrade screen. Select the desired upgrade file and press the button. The system restarts automatically after completing the upgrade.

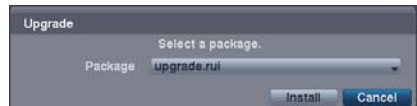

- **Setup:** Imports saved DVR settings or exports the current DVR settings.

*Import...* – To import saved DVR settings, connect a USB flash drive containing the setup file to the DVR and select the desired setup file. Checking the **Include Network Setup** box changes the network settings.

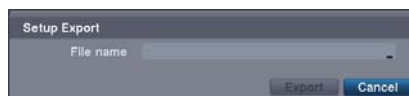
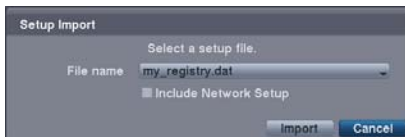

*Export...* – To save the current DVR settings in .dat file format, connect a USB flash drive to the DVR and enter a file name for the settings.



**NOTE:** Even after changing the DVR settings by importing saved settings, the time-related settings (Date/Time, Time Zone and Daylight Saving Time) will NOT be changed.



**CAUTION:** The USB device must be FAT16 or FAT32 format.

- **Show System Log...**: Displays the system logs (up to 5,000 from the latest). The  icon will be displayed in the last column for system activities of remote sites. To export the system log information, connect the USB device to the DVR. Select **Export...** and press the  button, and the System Log Export screen displays. Select the box beside **File name** and press the  button. A virtual keyboard allows you to enter the file name.



| Log Message             | Log Message                 | Log Message                   |
|-------------------------|-----------------------------|-------------------------------|
| Boot Up                 | Setup Export Cancel         | Backup End (Local/Remote)     |
| Upgrade (Local)         | Schedule On                 | Backup Cancel (Local/Remote)  |
| Upgrade Failure (Local) | Schedule Off                | Backup Failure (Local/Remote) |
| Setup Begin             | Clear All Data (Local)      | Time Change (Local)           |
| Setup End               | Format Disk                 | Time Zone Change (Local)      |
| Setup Imported          | Auto Deletion               | DISK FULL                     |
| Setup Import Fail       | Search Begin (Local/Remote) | Shutdown                      |
| Setup Exported          | Search End (Local/Remote)   | Restart                       |
| Setup Export Fail       | Backup Begin (Local/Remote) | DISK# BAD                     |

- **Change Password...**: Changes the password.
- **System Shutdown**: Shuts the system down.



**Date/Time Settings (SYSTEM → Date/Time Tab)**

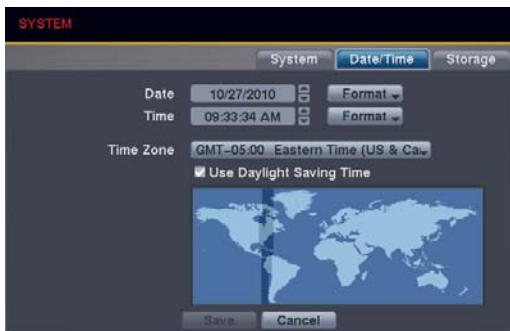

- **Date**: Set the system date, and select the date format.
- **Time**: Set the system time, and select the time format.
- **Time Zone**: Select your time zone.
- **Use Daylight Saving Time**: Selecting the box sets the system to use daylight saving time.

**NOTE:** The Time Zone can also be selected on the map below by pressing the Left and Right buttons or scrolling the mouse wheel up and down.

**NOTE:** The clock will not start running until you have selected the Save button.

## Storage Settings (SYSTEM → Storage Tab)

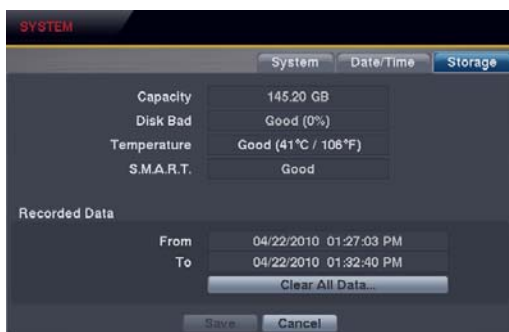

- **Capacity:** Displays the capacity of the storage drive.
- **Disk Bad:** Displays the damage status of the storage drive.  
*Not Formatted* – The device is not formatted.  
*Good (%)* – Less than user-defined percentage of bad disk sections is damaged.  
*Bad* – More than user-defined percentage of bad disk sections is damaged.
- **Temperature:** Displays the temperature of the storage drive.  
*N/A* – The DVR cannot read the temperature.  
*Good* – The temperature does not exceed the user-defined temperature threshold.  
*Bad* – The temperature exceeds the user-defined temperature threshold.

- **S.M.A.R.T.:** Displays S.M.A.R.T. (Self-Monitoring Analysis and Reporting Technology) information of the storage.  
*Good* – The storage condition is normal.  
*Bad* – Data cannot be written on or read from the storage drive.  
*N/A* – The S.M.A.R.T. monitoring is not working or supported.

**NOTE:** When the S.M.A.R.T. displays *Bad*, the screen displays a message box. Once the message box appears, replacing the hard disk drive is recommended, usually within 24 hours.

- **Recorded Data:** Displays the time information about recorded data on the drive. Selecting *Clear All Data...* will clear all video data except the system log. When the hard disk drive has not been formatted, the *Clear All Data...* button changes to the *Format...* button which is used to format the hard disk drive.

## NETWORK SETUP

### General Settings (NETWORK → General Tab)



- **Transfer Speed:** Set the transfer speed, and select the unit of measure for the transfer speed between bps (bits per second) and ips (images per second).
- **Quality:** Select the quality of the transferred image.

**NOTE:** The local recording speed might be affected by various network bandwidth (Transfer Speed) conditions.

**NOTE:** The higher Quality settings require higher Transfer Speed settings. The transfer speed you set is the maximum speed. Depending on the network environment, this speed may not be achieved.

- **Remote Audio Channel:** The DVR supports remote audio communication between a PC running REVO Remote Pro or REVO Remote and a local system. Select the audio channel that sends audio to the remote site. Selecting *Select From REVO Remote* will send audio of the channel selected from REVO Remote Pro or REVO Remote.

**NOTE:** Depending on network conditions, audio might be interrupted or out of synchronization during transmission.

- **Network Bandwidth Limit:** You can limit the network bandwidth settings so that system does not consume too much network bandwidth. Set the desired maximum bandwidth from 10Kbps to 100Mbps.

**NOTE:** When limiting the network bandwidth, the remote watch image on the PC running REVO Remote Pro or REVO Remote might not be displayed properly.

- **Enable SSL for Transferring Data:** Selecting the box turns the SSL (Secure Sockets Layer) authentication On. When it is On, the security of data, except video transmitted for remote monitoring or remote recording can be enhanced by using the SSL (Secure Sockets Layer) authentication. When using the SSL function, the DVR cannot be connected with a remote program or a network keyboard which does not support the SSL function.



**CAUTION:** The remote connection will be disconnected temporarily after changing the SSL settings.

**NOTE:** This product includes software developed by the OpenSSL Project for use in the OpenSSL Toolkit (<http://www.openssl.org/>).

- **Use REVO Remote Service:** Selecting the box turns the REVO Remote service On. Select the port number used when accessing REVO Remote. See *Appendix – REVO Remote* for details.
- **Mac Address:** Displays the MAC (Media Access Control) address of the DVR.

## Network Settings (NETWORK → Network Tab)

The screenshot shows the NETWORK settings window with the 'Network' tab active. The 'Type' dropdown is set to 'Manual'. The IP Address is 192.168.1.129, Gateway is 192.168.1.254, and Subnet Mask is 255.255.255.0. The DNS Server is set to 0.0.0.0 with an 'Auto' checkbox. There are buttons for 'Port Number Setup...', 'Use UPnP', 'Status', 'Save', and 'Cancel'.

- **Type:** Select the type of network configuration from: Manual, DHCP and ADSL (with PPPoE).

*Manual* – You can select Manual when using a static IP address for network connection. Set up LAN parameters manually. Set the numbers of the IP Address, Gateway and Subnet Mask.

*DHCP* – You can select DHCP when the DVR is networked through DHCP (Dynamic Host Configuration Protocol). The DVR reads the IP address from DHCP network when selecting the Save button.

*ADSL* – You can select ADSL (with PPPoE) when the DVR is networked through ADSL. Enter the ID and password for ADSL connection, and the DVR receives the IP address when selecting the Save button.

The screenshot shows the NETWORK settings window with the 'Network' tab active. The 'Type' dropdown is set to 'DHCP'. The IP Address is 1.2.3.4, Gateway is 5.6.7.8, and Subnet Mask is 9.10.11.12. The DNS Server is set to 0.0.0.0 with an 'Auto' checkbox. There are buttons for 'Port Number Setup...', 'Use UPnP', 'Status', 'Save', and 'Cancel'.

The screenshot shows the NETWORK settings window with the 'Network' tab active. The 'Type' dropdown is set to 'ADSL (with PPPoE)'. The IP Address is 1.2.3.4. There are input fields for 'ID' and 'Password'. The DNS Server is set to 0.0.0.0 with an 'Auto' checkbox. There are buttons for 'Port Number Setup...', 'Use UPnP', 'Status', 'Save', and 'Cancel'.

**NOTE:** Ask your network provider for your network connection type and connection information.

**NOTE:** If the DVR is configured for DHCP or ADSL, the IP address of the DVR might change whenever the unit is turned on. If you want to use the DVRNS function, you will need to get the IP Address of the DNS Server from the Internet service provider.

- **DNS Server:** Set the DNS server IP address obtained from your network administrator. If you set up the DNS Server, the domain name of the DVRNS server or SMTP server instead of the IP address can be used during DVRNS Server or Mail setup. Checking the Auto (Default) box allows the DVR to obtain the IP address of the DNS server automatically.

**NOTE:** Selecting *Auto* will only be enabled when the DVR is configured for DHCP or an ADSL network.

- Port Number Setup...: Set the port number of each remote software related program.

**NOTE:** You will need to get the appropriate Port Numbers for each remote software related program from your network administrator. Do NOT use the same port number for two different programs, otherwise, the DVR cannot be connected with the PC running REVO Remote Pro or REVO Remote.



**CAUTION:** When changing the port settings, you must change the port settings on the PC running REVO Remote Pro.

- Use UPnP: Check the box when using the UPnP (Universal Plug and Play) service. When using the UPnP service, port forwarding from the NAT (Network Address Translation) device to the DVR will be enabled automatically via UPnP service. This function will be especially useful when accessing a port on a private IP address. Checking the Status box displays the port numbers forwarded from the NAT device via UPnP service.

**NOTE:** For the UPnP service to work, the NAT device should support the UPnP Port Forwarding function and the function should be set to enabled.

**NOTE:** You cannot change the port settings when Use UPnP is On.

## DVRNS Settings (NETWORK → DVRNS Tab)



**NOTE:** The DVRNS (DVR Name Service) allows you to connect to the DVR, via internet, with the dynamic IP address or the domain name. To make this feature easy, you can name your DVR (example: TomStore05) and connect using the DVR name instead of the IP address. To use the DVRNS feature, you will need to have your DVR registered through DVRNS with the settings matched between your DVR and the DVRNS server. Any changes to the DVRNS server might cause improper operation.

**NOTE:** When Network settings have been changed, set up the DVRNS after saving your Network changes by selecting the Save button.

- Use DVR Name Service: Checking the box when using the DVR Name Service function. You will only be able to change the settings if Use DVR Name Service is enabled.
- DVRNS Server: Enter the IP address or domain name of the DVRNS server.

**NOTE:** You will need to get the IP address or domain name of the DVRNS server from your network administrator. You can use the domain name instead of IP address if you set up the DNS server during Network setup.

- Port: Set the port number of the DVRNS server.
- DVR Name: Enter the DVR name to be registered on the DVRNS server. Check whether or not the name you entered is available by selecting the Check button.

**NOTE:** The DVR name you entered should be checked by selecting the Check button, otherwise the DVRNS changes will not be saved. When no name is entered or a name is already registered on the DVRNS server, an error message displays.

- Help Desk: Selecting the Save button registers the DVR on the DVRNS server. Proper DVRNS settings will cause the help desk information of the DVRNS server to display.



- **Dashboard – Setup:** Select the button and set up the Dashboard. Select **New account** if you want to create a new Dashboard account, and select **Existing account** if you want to use your existing Dashboard account. Enter the User ID and Password for your Dashboard account. And then select the **Register/Add a new DVR** button to register the DVR on the REVO Dashboard.



**RTSP Settings (NETWORK → RTSP Tab) (Blackberry Users and Others)**



- **Enable RTSP:** Selecting the box enables the RTSP (Real-Time Streaming Protocol) service. You will be able to change the settings if Enable RTSP is enabled.  
**NOTE: When selecting *Enable RTSP*, the recorded image resolution cannot be set to *Very High* during Record setup.**
- **RTSP Port:** Set the port number of the RTSP server obtained from your system administrator.
- **RTP Port:** Set the Start Port and End Port numbers of the RTP server obtained from your system administrator.
- **Use Mobile:** Selecting the box when using Blackberry or other mobile devices.

**NOTE:** Selecting *Use Mobile* sets the recorded image resolution to *Basic* automatically regardless of your Record settings.

**NOTE:** Selecting *Use Mobile* sets the REVO Remote service to be enabled automatically regardless of your Network – General settings.

**NOTE:** When using NAT (Network Address Translation) or firewall services, opening all UDP ports allows you to access a DVR using Blackberry and Android devices.

**NOTE:** You can access a remote DVR and monitor live video images using media players, such as VLC Player, supporting RTSP service. Start the media player on your local PC and enter “rtsp://ID:Password@IP address: RTSP port number/trackID=‘channel number’”, or start Internet Explorer on your Blackberry or other mobile devices and enter “http://IP address:REVO Remote port number/”.

**NOTE:** Some media players might play video properly depending on network conditions.

**NOTE:** RTSP service might not be supported, depending on the type of media player.

**Mail Settings (NETWORK → Mail Tab)**



- **No.:** Selecting the box toggles all or each Recipient On and Off.
- **+**: Adds a mail recipient.

- **Recipient:** Enter the recipient's e-mail address and select the mail server provider. The e-mail address must include the "@" character to be a valid address.



- **X:** Deletes the mail accounts.
- **SMTP Setup:** Select the button and set up the SMTP server.

*Type* – Select between Manual and listed SMTP mail server providers.  
*SMTP Server* – Enter the SMTP server IP address or domain name obtained from your system administrator.

**NOTE: You will need to get the IP address or domain name of the SMTP server from your network administrator. You can use the domain name instead of IP address if you set up the DNS server during Network setup.**



*Port* – Set the SMTP server port number obtained from your system administrator.

*Use SSL/TLS* – Check the box when sending an e-mail via an SMTP server requiring SSL (Secure Sockets Layer) authentication.

*Authentication* – Select the button if the SMTP server needs authentication, and set up the Authentication by selecting the Use box and entering the user ID and password.

**NOTE: This product includes software developed by the OpenSSL Project for use in the OpenSSL Toolkit (<http://www.openssl.org/>).**



*Sender* – Enter the sender's e-mail address. The e-mail address must include the "@" character to be a valid address.

## Push Settings (NETWORK → Push Tab)



- **Push:** Selecting the box enables the Push Notification service.
- **Push Server:** Displays the push server address.
- **Ignoring Time:** Set the push ignoring dwell time. The DVR will not send callback messages during the preset interval range when the same event is detected.

## Schedule Settings (NETWORK → Schedule Tab)

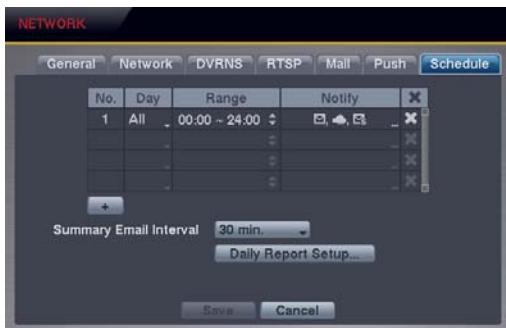

- **+**: Adds the notify schedule.
- No.* – Indicates a schedule number. The higher the number, the higher its priority. (i.e. The schedule No. "20" has priority over all others.)
- Day* – Select the days that the DVR notifies the remote site.
- Range* – Set the time range that the DVR notifies the remote site.
- Notify* – Set the notify actions that the DVR will take when the event is detected.
- **X** – Deletes the notify schedule settings.
- **Summary Email Interval:** Set the interval that you want the DVR to send a summary email. The DVR will send an email containing a summary of events detected during the preset interval range.

- **Daily Report Setup...**: Select the button and set up the daily report of event detection. Checking the **Enable** box enables the daily report setup. Set the reporting time and time range of daily report and select the cameras for which you want the daily report of events, and the DVR will send an email of daily report based on the reporting condition you made.



## CAMERA SETUP

### Camera Settings



- **No.:** Selecting the box toggles all or each camera On and Off.
- **Title:** Change the name of all or each camera.
- **PTZ Model:** Select the PTZ device you wish to configure from the list.
- **ID:** Set the PTZ ID of each camera.

- **PTZ Port Setup...**: Select the button and set up the PTZ device you are connecting to the DVR. Check the **Enable RS485** box and set the port's setting according to the PTZ device manufacturer's instructions.



## RECORD SETUP

### Record Settings (RECORD → Settings Tab)



- **Recycle:** Selecting this box records over the oldest video data once all available storage space has been used. When the box is not checked, the DVR stops recording once all available storage has been used.
- **Resolution:** Selecting this box records over the oldest video data once all available storage space has been used. When the box is not checked, the DVR stops recording once all available storage has been used.

**NOTE:** The total ips of all camera channels will be limited to 120 ips (60 ips for 4-ch Model) when set to **High** resolution and 60 ips (30 ips for 4-ch Model) when set to **Very High** resolution.

**NOTE:** When set to *High* or *Very High* resolution, the maximum recording speed of each camera channel might decrease so as not to exceed the total ips of all camera channels. The 8-channel DVR has two camera groups (No. 1: cameras 1 to 4 and No. 2: cameras 5 to 8), and setting resolution will be applied to all the cameras within the same camera group. See the table below.

| No. of cameras set to <i>On</i> and <i>High</i> resolution |        |        |        |        |
|--|--------|--------|--------|--------|
| 0  | 1      | 2      | 3      | 4      |
| —  | 30 ips | 30 ips | 20 ips | 15 ips |

| No. of cameras set to <i>On</i> and <i>Very High</i> resolution |        |        |        |         |
|---|--------|--------|--------|---------|
| 0   | 1      | 2      | 3      | 4       |
| —   | 30 ips | 15 ips | 10 ips | 7.5 ips |

- Record Audio: Selecting the box records audio from up to eight inputs when video is recording.
- Auto Deletion: Adjust the length of time recorded data will be kept by using the slide bar or Up and Down arrows buttons. Selecting Never will disable the Auto Deletion function. The DVR automatically deletes video recorded earlier than the user-defined period under three conditions: at midnight, whenever the system reboots or whenever the user changes the Auto Deletion settings.

### Panic Record Settings (RECORD → Panic Record Tab)



- Use Panic Recording: Check the box when using the Panic recording function.
- Panic Recording Duration: Set the duration of panic recording. Panic recording will stop automatically after the preset duration as long as the PANIC button on the remote control is not pressed to stop the panic recording.
- Panic Recording ips: Set the images per second for Panic recording.
- Panic Recording Quality: Set the recorded image quality for Panic recording.

### Schedule Settings (RECORD → Schedule Tab)

The DVR provides two recording schedule modes: Basic and Advanced. The Basic schedule mode allows you to set recording settings for all camera channels at one time. The Advanced schedule mode allows you to set recording settings for each camera channel.

#### Setting up the Basic Schedule Mode...

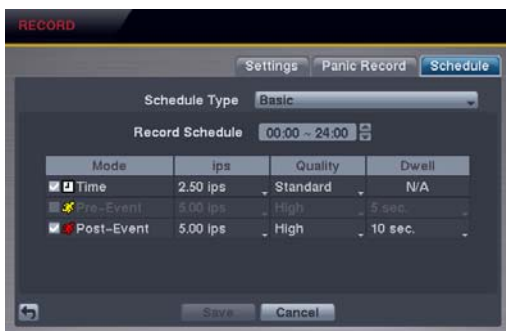

- Schedule Type: Select the Basic schedule mode.
- Record Schedule: Select the time range that the scheduled recording will take place.
- Mode: Select the desired recording mode. [Time] Time (Time-lapse) recording, yellow [Pre-Event] Pre-Event recording, red [Post-Event] Post-Event recording, [Time & Post-Event] Time & Post-Event recording, yellow [Pre-Event] & red [Post-Event] Pre-Event recording & Post-Event recording)
- ips: Set the images per second for the selected recording mode.
- Quality: Set the recorded image quality for the selected recording mode.
- Dwell: Set the length of time you would like to record for the selected recording mode.

## Setting up the Advanced Schedule Mode...



- Schedule Type: Select the Advanced schedule mode.

- Pre-Event Record: Selecting Setup... allows you to set up the pre-event recording by setting the ips, Quality and Dwell for each selected camera channel.



- Post-Event Record Dwell: Set the length of time you would like to record for the associated event.
- Add Schedule...: Adds a schedule item. Up to 20 schedules can be registered.

*No.* – Indicates a schedule number. The higher the number, the higher its priority. (i.e. The schedule No. “20” has priority over all others.)

*Day* – Select the days that the recording will take place.

*Range* – Set the time range that the recording will take place.

*Mode* – Select the recording mode. (□): Time (Time-lapse) recording, (🔴): Event recording, (□🔴): Time & Event recording)

*Channels* – Select which cameras will be recorded.

*Settings* – Set the ips, Quality and Dwell of the recording for the selected recording mode in the Mode column. If you do not set the Settings column, the DVR will follow the default settings. See below for details.

✕ – Deletes the recording settings.

**NOTE:** *Day*, *Range* and *Channels* that are not defined will use the setting values of the previous schedule item.

**NOTE:** When more than two schedule items are registered in the same day and time range, the DVR will follow the latest registered schedule item.

## EVENT SETUP

### Motion Event Settings (EVENT → Motion Tab)



- No.: Your DVR has built-in motion detection. Selecting the box turns the motion detection On and Off for each camera.

- Sensitivity:** Set the DVR's sensitivity to motion for Daytime and Nighttime independently from 1 (the least sensitive) to 5 (the most sensitive).



- Zone:** Define the area of the image where you want to detect motion; e.g., a doorway. The Motion Detection Zone screen is laid over the video from the selected camera. You can set up motion zones one block at a time in groups of three or six individual block groups (4- and 8-channel DVR respectively). A block group is positioned within the image area using the arrow buttons on the remote control, and individual blocks within the block groups are selected or cleared using the camera buttons on the remote control. Pressing the button on the remote control or clicking the right mouse button displays the menu screen. Each item in the menu has the following functions:

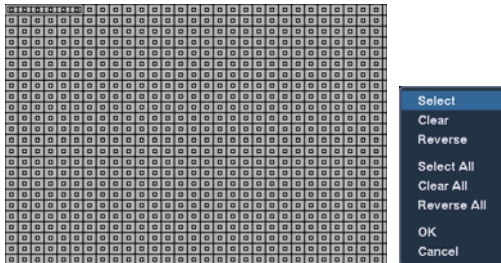

- Select/Select All* – Activates highlighted blocks or all blocks to detect motion.
- Clear/Clear All* – Deactivates highlighted blocks so that they will not detect motion.
- Reverse/Reverse All* – Activates inactive highlighted blocks or all inactive blocks and deactivates active highlighted blocks or all active blocks.
- OK* – Accepts changes and closes Zone setup.
- Cancel* – Exits Zone setup without saving changes.

**NOTE:** You can select the block groups to be selected or cleared by using the mouse. Place the mouse pointer where you want to start the line. Hold down the left mouse button and drag the pointer to where you want to end of the line. Release the mouse button and a group of blocks appears along the line you drew. You can draw lines around shapes by repeating this process.

- Min. Blocks:** Set the minimum number of detection blocks that must be activated to trigger a motion alarm for Daytime and Nighttime independently.



- Actions:** Set the actions the DVR will take whenever motion is detected on the selected camera. Motion event can sound the external alarm or DVR's internal buzzer, notify a number of different devices, and/or move PTZ cameras to preset positions.



*Alarm Out* – Select the alarm-out signals (Alarm-Out and Beep) to be associated with the camera.

*Notify* – Select Mail if you want to send an e-mail to the address set during *NETWORK – Mail* setup.

*PTZ* – Select the preset position for each PTZ camera, where you want PTZ cameras to move to.

**NOTE:** For the Notify action to work, the Mail should be enabled in the *NETWORK – Mail* setup.

- **Motion Ignoring Interval:** Set the motion ignoring dwell time. You can control excessive event logging and remote notification of motion detected after the motion dwell time by adjusting the motion ignoring dwell intervals. The DVR will not log and notify motion events occurred during the preset interval range. The recording for motion events will not be affected by the Motion Ignoring function.
- **Daytime Setup...**: Select the button and set the Daytime range. The DVR will consider the remaining time range as the nighttime.

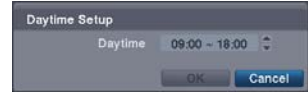

## Alarm-In Event Settings (EVENT → Alarm-In Tab)



- **No.:** Selecting the box toggles each alarm input On and Off.
- **Type:** Set each alarm input as NO (Normally open) or NC (Normally closed).

- **Actions:** Set the actions the DVR will take whenever an input is detected on the selected alarm input. Alarm-In event can sound the external alarm or DVR's internal buzzer, notify a number of different devices, and/or move PTZ cameras to preset positions.

*Alarm Out* – Select the alarm-out signals (Alarm-Out and Beep) to be associated with the alarm input.

*Notify* – Select Mail if you want to send an e-mail to the address set during *NETWORK – Mail* setup.

*PTZ* – Select the preset position for each PTZ camera, where you want PTZ cameras to move to.



**NOTE:** For the Notify action to work, the Mail should be enabled in the **NETWORK – Mail** setup.

## System Event Settings (EVENT → System Tab)



- **Settings:** Set up the DVR to run self-diagnostics.

*System* – Select the interval that you want the DVR to run self-diagnostics on the system.

*Check Recording* – Selecting the column allows you to set up the check recording schedule by selecting **Schedule On**. Selecting **+** allows you to add a check recording schedule by setting the day, time range and interval that you want the DVR to run self-diagnostics on the recorder. Selecting **X** allows you to delete a check recording schedule.

*Check Alarm-In* – Selecting the column allows you to change interval the DVR to run self-diagnostics on alarm inputs.

*Disk Almost Full* – Select the percentage level of disk usage at which you want the DVR to trigger an alert.

*Disk Bad* – Select percentage level of bad disk sectors at which you want the DVR to trigger an alert.

*Disk Temperature* – Set the temperature threshold and (°C (Celsius) or °F (Fahrenheit)). If the temperature of hard disk drive exceeds the defined threshold, the system triggers an alert.



- **Actions:** Set up actions the DVR will take whenever it detects system events. System events can sound the DVR's internal buzzer, notify a number of different devices and/or move PTZ cameras to preset positions.  
**NOTE: The Alarm Out action cannot be set to System, Boot Up, Restart, Shutdown and Panic Record events.**  
**NOTE: For the Notify action to work, the Mail should be enabled in the NETWORK – Mail setup.**
- **Beep on Video Loss:** Set to sound the DVR's internal buzzer when video is lost.

## DISPLAY SETUP

### OSD Settings (DISPLAY → OSD Tab)



- **Status/Camera:** Check each OSD item box to turn it On or Off.  
*Remote Control* – The icon displays when the DVR can be controlled using the infrared remote control.  
*Zoom* – The icon displays on the enlarged video.  
*Network* – The icon displays when the unit is connected to a network via Ethernet. The icon displays when audio communication is available between the DVR and a PC running REVO Remote Pro or REVO Remote via Ethernet.  
*Freeze & Sequence* – The icon displays while in the Freeze mode, and the icon displays while in the Sequence mode.

*Screen Group* – The screen group number displays when the DVR is in other than the 3x3 display mode for the 8-channel DVR, and 2x2 mode for the 4-channel DVR.  
*Free Space* – The icon displays when the DVR is in the Recycle mode. The percentage of available storage space displays when the DVR is not in the Recycle mode.  
*Date/Time* – The current date and time information displays.  
*User Name* – The name of the current user logged in displays.  
*Camera No.* – The camera number displays in the top-left corner of each camera screen.  
*Camera Title* – The camera title displays in the top-left corner of each camera screen.  
*Record* – The record related icons display on each camera screen.  
*Audio* – The icon displays when the DVR can play audio.  
*PTZ* – The icon displays on each PTZ camera screen with PTZ capabilities.

- **Transparency:** Adjust the transparency of the setup screens by using the slide bar.
- **OSD Margin...:** Set the Horizontal and Vertical margins so that text and icons will display within the edges of the monitor.





## Main Monitor Settings (DISPLAY → Main Monitor Tab)

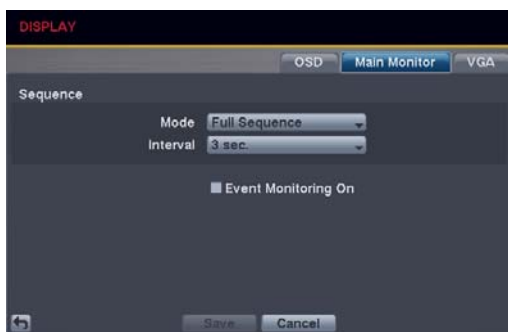

- **Sequence – Mode:** Select the sequence mode between Full Sequence and Cameo Sequence. (8-ch model only) Selecting the *Sequence* menu icon at the top of the screen or pressing the **SEQUENCE** button on the remote control causes the DVR to sequence cameras. The DVR can sequence cameras in two modes: “Full” and “Cameo.” In the Full mode, the DVR sequences through the cameras with predefined screen layouts. In the Cameo mode, the bottom right window of a multi-screen format sequences through the cameras. See *Chapter 3 – Operation, Live Monitoring* for details.

**NOTE:** You can define the screen layout in a variety of formats and set the DVR to sequence through the different screen layouts (pages) so that all the cameras will be displayed. You also can set up the DVR to display one camera or a group of cameras all the time while cycling through the remaining cameras in a “cameo” window. This can be done with one camera displayed full screen while displaying the cameo window as a PIP (picture-in-picture), or displaying the cameras in a grid pattern with the bottom right window as the cameo.

**NOTE:** Sequence cannot be used in the 3x3 display mode of the 8-channel DVR or 2x2 mode of the 4-channel DVR.

- **Sequence – Interval:** Select the display dwell time of sequence monitoring.
- **Event Monitoring On:** Selecting the box turns the Event Monitoring On. When it is On, the DVR will display the camera associated with the event when an event occurs. See *Chapter 3 – Operation, Live Monitoring* for details.

## VGA Settings (DISPLAY → VGA Tab)



- **Resolution:** Set the resolution of the VGA monitor.
- **Test:** Selecting the button allows you to test how the screen will be displayed with the resolution you set.



## Chapter 3 — Operation

**NOTE:** This chapter assumes your DVR has been installed and configured. If it has not, please refer to *Chapter 2*.

### LIVE MONITORING

As soon as the DVR completes its initialization process, it will begin displaying live video on the attached monitor and playing live audio through the attached speaker. The default mode is to display all cameras at once. Pressing any camera button on the remote control will cause that camera to display full screen. The DVR continues displaying live video and playing live audio until the user enters another mode.

Press the MENU button on the remote control, and the following menu icons display at the top of the screen. Pressing the MENU button again hides the menu icons. You can navigate through menus and items by pressing the arrow buttons on the remote control.



- ① Freeze
- ② Sequence
- ③ Camera Menu
- ④ Alarm
- ⑤ Panic
- ⑥ Setup
- ⑦ Search Mode
- ⑧ Login/Logout

**NOTE:** The menu icons also can be displayed by moving the mouse pointer to the top of the screen.

#### Freeze

Selecting the ❄️ (Freeze) icon will freeze the current image on the screen until you select Freeze again. It is the same as pressing the FREEZE button on the remote control. Selecting the ❄️ icon again exits the Freeze mode. While in the Freeze mode, the ❄️ icon displays in bottom-left corner if Freeze is selected in the Display setup screen (OSD tab).

#### Sequence

Selecting the 🔄 (Sequence) icon causes the cameras to display sequentially. It is the same as pressing the SEQUENCE button on the remote control. When in one of the multiview formats, selecting *Sequence* will cause the DVR to go through predefined screen layouts (Full Sequence). Or, the bottom, right screen will display live cameras sequentially (Cameo Sequence). For example, if you select the 🔄 icon in the 2x2 format, the DVR changes pages as follows:



Full Sequence

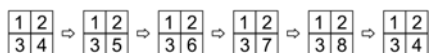

Cameo Sequence





Selecting another display mode or selecting the 🔄 icon again exits the Sequence mode. While in the Sequence mode, the 🔄 icon displays in bottom-left corner if Sequence is selected in the Display setup screen (OSD tab).

**NOTE:** *Full Sequence* for the full sequence monitoring and the *Cameo Sequence* for the cameo sequence monitoring should be selected in the Display setup screen (Main Monitor tab).

## Camera Menu

Selecting the  (*Camera Menu*) icon displays the following Camera Menu.



- **PTZ:** Selecting *PTZ* and choosing the camera number allows you to control the selected camera as long as it has Pan, Tilt and Zoom capabilities. Selecting *PTZ* is the same as pressing the PTZ button on the remote control. See the following *PTZ Mode* section for details.
- **Zoom:** Selecting *Zoom* and choosing the camera number zooms the current image of the selected camera on the screen. Selecting *Zoom* is the same as pressing the ZOOM button on the remote control. For a few seconds after selecting *Zoom*, a PIP displays. Inside the PIP, a rectangle shows the area that is enlarged. You can move the rectangle around using the arrow buttons on the remote control. Pressing the  button on the remote control enlarges the area. Selecting the  (*Exit*) icon at the top of the screen by pressing the MENU button on the remote control exits the Zoom mode. You also can exit the Zoom mode by pressing the ZOOM button on the remote control. While in the Zoom mode, the  icon displays in bottom-left corner if ZOOM is selected in the Display setup screen (OSD tab).
- **Audio:** Selecting *Audio* while in the full-screen mode toggles playing live audio On and Off. While playing live audio, the  icon displays on the camera screen if Audio is selected in the Display setup screen (OSD tab).
- **Color Control:** Selecting *Color Control* and choosing the camera number displays an image adjustment dialog. Selecting *Color Control* and choosing the camera number is the same as pressing and holding a camera button on the remote control for a few seconds. You can control brightness, contrast, hue and saturation for each camera.

**NOTE: It is important that cameras and monitors are correctly installed and adjusted prior to making any image adjustments using the DVR's controls.**

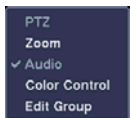

**NOTE: Any image adjustments you make will be applied to both the live video on the monitors and the recorded video.**

**NOTE: The Camera Menu also can be displayed by clicking the right mouse button on each camera screen.**





- **Edit Group:** Supports the active cameo function. (8-ch model only) Select *Edit Group* and choose a camera that you want to change display position (e.g., Camera A). Then, click the right mouse button to display the menu. If you choose another camera in the menu (e.g., Camera B), the screen displays Camera B instead of Camera A. Clicking the right mouse button and selecting *Exit Group Edit* in the menu exits the Active Cameo mode. See the following *Active Cameo Mode* section for details.

## Alarm

Selecting the  (*Alarm*) icon resets the DVR's outputs including the internal buzzer during an alarm. Selecting the  icon is the same as pressing the ALARM button on the remote control.

## Panic

Selecting  (*Panic*) in the Live Monitoring menu starts panic recording of all cameras, and displays  on the screen. Selecting  again stops panic recording. It is the same as pressing the PANIC button on the remote control.

## Setup

Selecting the  (*Setup*) icon enters the Main Setup screen.

## Search Mode

Selecting the  (*Search Mode*) icon exits the Live Monitoring mode and enters the Search mode.

## Login/Logout

Selecting **F1** (*Login*) in the Live Monitoring menu accesses the Login screen, and you will be asked to enter the password to log into the system. Selecting **F3** (*Logout*) in the Live Monitoring menu displays the Logout screen asking you to confirm whether or not you want to log out the current user.



## DISPLAY MENU

In the Live Monitoring mode or Search mode, moving the mouse pointer to the left edge of the screen displays the following Display menu icons.





- ① Full Screen
- ② PIP
- ③ 2x2
- ④ 3x3
- ⑤ Previous Group
- ⑥ Next Group
- ⑦ OSD

### Full Screen

Selecting the  (*Full Screen*) icon displays the selected camera full screen. Selecting the  icon and choosing the camera number is the same as pressing the individual camera buttons on the remote control or clicking the left mouse button on a camera image when in one of the multiview formats (i.e., 2x2 or 3x3). Clicking the left mouse button on the screen again returns to the previous display mode.

### PIP, 2x2, 3x3

Selecting the , , or  (*PIP*, *2x2* or *3x3*) icon displays the cameras in the selected multiview screen mode (PIP, 2x2 or 3x3). Selecting each display mode is the same as pressing the LAYOUT button on the remote control or scrolling the mouse wheel up and down when in one of the multiview formats (i.e., 2x2 or 3x3).





**NOTE:** The location of camera screen can be changed by using the mouse. When in one of the multiview formats, click the left mouse button on the camera screen and dragging it to where you want it located, and the location of two camera screens will be switched each other.

**NOTE:** The PIP display mode will not be supported in the Search mode.

You can change the location of the PIP (Picture-in-Picture) counterclockwise or clockwise by pressing the Up and Down arrow buttons on the remote control. To change its location and size by using the mouse, select the PIP and then click the right mouse button to display the following menu. Select the options you want. You can also change the size of the PIP by clicking the left mouse button at the corner of the PIP window and dragging it until it is the desired size.



### Previous Group, Next Group

Selecting the  or  (*Previous Group* or *Next Group*) icon moves to the previous or next page. Selecting the  or  icon is the same as pressing the Left or Right buttons on the remote control.

### OSD

Selecting the  (*OSD*) icon toggles OSD On and Off.



## EVENT MONITORING

When an event occurs, the DVR will display the camera associated with that event if Event Monitoring On is selected in the Display setup screen (OSD tab).

How the cameras are displayed depends on the number of cameras associated with the event. If one camera is associated with the event, the DVR will display that camera full screen. If two to four cameras are associated with the event, the DVR will display the cameras on a 2x2 screen. If five to eight cameras are associated with the event, the DVR will display the cameras on a 3x3 screen.



Event monitoring lasts for the dwell time set for event recording. After the dwell time has elapsed, the monitor returns to the previous screen unless another event has occurred. If you want to return to the live monitoring mode before the dwell time has elapsed, press the LAYOUT or one of the camera buttons on the remote control.



## ACTIVE CAMEO MODE

You can enter the Active Cameo mode by pressing the  button on the remote control while in any multiview format. (8-ch model only) A yellow outline surrounding the video indicates the active cameo, and pressing the arrow buttons moves the active cameo. Pressing the  button while in the Active Cameo mode exits the Active Cameo mode. You also can exit the Active Cameo mode by clicking right mouse button and selecting *Exit Group Edit* in the menu. The active cameo mode will remain in effect for 15 seconds if there is no further operation.



In active cameo mode, press the camera button on the remote control for the camera you want displayed as active cameo. After setting the camera number to active cameo, the DVR moves the active cameo to the next cameo. You can use this method to change the screen layout in this way.

## PTZ MODE

In the Live Monitoring mode, press the MENU button on the remote control or move the mouse pointer to the top of the screen to display the  (*Camera Menu*) icon on the screen. Selecting PTZ and choosing the camera number from the Camera Menu enters the PTZ mode. Only camera numbers that are set up for PTZ control during Camera setup can be selected in the list. To exit the PTZ mode, select the  (*Exit*) icon at the top of the screen displayed by pressing the MENU button while in the PTZ mode. You also can enter the PTZ mode by pressing the PTZ button and selecting the camera button on the remote control and exit the PTZ mode by pressing the button again. While in the PTZ mode, the  icon flickers on the PTZ camera screen if PTZ is selected in the Display setup screen (OSD tab).

Press the Left and Right arrow buttons on the remote control to pan left and right, and press the Up and Down arrow buttons to tilt the camera up and down. Press the ZOOM + button to zoom in, and the ZOOM – button to zoom out. You can use the FOCUS  and FOCUS  buttons to focus the image.

You can establish preset positions for PTZ cameras. Press the PRESET SET button to create or change Presets. You can quickly move PTZ cameras to Preset positions. Press the PRESET SELECT button to view an established camera Preset position or click the right mouse button on the PTZ camera screen.

You can save camera position settings as “presets” so that you can go directly to desired views. Once you have the camera at the desired settings, press the PRESET SET button, and the *Set Preset* dialog box will appear. Select the number you want to assign to the preset and press the  button on the remote control. Use the virtual keyboard to enter the preset name. Press the PRESET SELECT button to load the PTZ preset and the *Move to Preset* dialog box will appear. Select the desired preset and press the  button on the remote control to load the preset. You also can load the preset using the mouse. Click the right mouse button on the PTZ camera screen and select the desired preset.

**NOTE:** The Preset menu also can be displayed by clicking the right mouse button on the screen while in the PTZ mode.

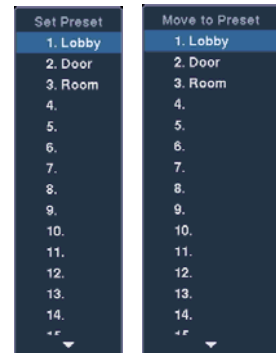









While in the PTZ mode, pressing the MENU button on the remote control displays the menu icons at the top of the screen. Selecting the  (Advanced PTZ) icon displays the following the PTZ menu. Set the feature you wish to control by selecting it from the menu. Refer to the camera's instructions for the proper settings. Depending on the camera specifications, some features may not be supported.



You also can use the mouse for convenient PTZ control. Position the mouse pointer at the bottom of the screen, and the following PTZ toolbar displays.



Clicking  on the left side exits the toolbar. If you want to display the toolbar again, position the mouse pointer at the bottom of the screen. Change the toolbar location by clicking the empty space on the left side of the toolbar and dragging it to where you want it located on the screen. Use the arrow buttons on the toolbar to pan or tilt the camera in the direction you want. The other controls on the toolbar perform as described below:



  Zoom In or Out        Focus Near or Far  
  Iris Open or Close        Set or Load Preset

## RECORDING VIDEO

Once you have installed the DVR following the instructions in *Chapter 2 — Installation and Configuration*, it is ready to record. The DVR will start recording based on the settings you made in the Record setup screen.

**Recycle On or Recycle Off.** The factory default is Recycle On (Recycle When Disk Full). It does this by recording over the oldest video once the hard disk is full. Setting the DVR to Recycle Off causes it to stop recording once the hard disk is full.

**Standard (CIF), High (Half D1) or Very High (D1).** The factory default resolution is High. When set to High, the DVR has a maximum recording speed of 120 ips (60 ips for 4-channel DVR). When set to Standard, the DVR has a maximum recording speed of 240 ips (120 ips for 4-channel DVR). When set to Very High, the DVR has a maximum recording speed of 60 ips (30 ips for 4-channel DVR).

Selecting  (Panic) in the Live Monitoring menu or pressing the PANIC button on the remote control starts panic recording of all cameras, and selecting  again stops panic recording. If you set the Panic Recording Duration in the Panic Record setup screen, panic recording will stop automatically according to the preset duration as long as  is not selected or the PANIC button is not pressed.

**NOTE: When the DVR is not in the Recycle mode and all available storage space has been used, panic recording will not operate.**

Although you will be able to record without changing the unit from its original factory settings, you will want to take advantages of the DVR's many tools. See *Chapter 2 — Installation and Configuration, Record Setup* for detailed descriptions of the recording mode options.

If the DVR was set up to record audio, it will record audio from up to eight inputs when video is recording.













**NOTE: Make certain you comply with all local and federal laws and regulations when recording audio.**

## PLAYING RECORDED VIDEO

While in the Live Monitoring, pressing the MENU button on the remote control displays the menu icons on the screen. Selecting the  (Search Mode) icon at the top of the screen exits the Live Monitoring mode and enters the Search mode.





Once video has been recorded, you can view it by pressing the  (Play/Pause) button on the remote control in the Search mode. When playing video for the first time, the DVR will display the most recent image. When playing video subsequent times, the DVR will start playing video from the last recalled image. Recorded audio will be played when the DVR displays a camera with recorded audio in full screen mode.

### Playback Related Buttons on the Remote Control

- **CAMERA Buttons:** Pressing the individual camera buttons will cause the selected camera to display full screen.
- **Playback Buttons**
  - Backward:** When in the pause mode, pressing the  button moves to the previous image.
  - Forward:** When in the pause mode, pressing the  button moves to the next image.
  - Rewind:** Pressing the  button plays video backward at high speed. Pressing the button again toggles the playback speed from  and .
  - Play/Pause:** Pressing the  button plays back video at regular speed. The screen displays  when the DVR is in the Pause mode and the screen displays  when the DVR is playing back video.
  - Fast Forward:** Pressing the  button plays video forward at high speed. Pressing the button again toggles the playback speed from  and .
  - Stop:** Pressing the  button stops playback and enters the Live Monitoring mode.
- **ZOOM Button:** Pressing the ZOOM button and selecting the camera button on the remote control zooms the current playback image of the selected camera. Pressing the ZOOM button again exits the Zoom mode. While in the Zoom mode, the  icon displays on the camera screen if Zoom is selected in the Display setup screen (OSD tab).
- **LAYOUT Button:** Pressing the button toggles between different display formats. The available formats are: 3x3, 2x2 and PIP.

You also can use the mouse for convenient playback control. Position the mouse pointer on the playback screen, and the following Record Table Search screen (Compact View mode) will display. Refer to the following *Searching Video – Search* section for information regarding the Record Table Search. The individual controls on the toolbar perform the following functions:



-  Go to the previous image
-  Play/Pause
-  Go to the next image
-  Fast backward play
-  Fast forward play

## SEARCHING VIDEO





While in the Search mode, pressing the MENU button on the remote control displays the following menu icons at the top of the screen. Pressing the MENU button again hides the menu icons.







- ① Search
- ② Go To
- ③ Export
- ④ Camera Menu
- ⑤ Alarm
- ⑥ Panic
- ⑦ Exit

**NOTE:** The menu icons also can be displayed by moving the mouse pointer to the top of the screen.

-  **Search:** Selects video from the event log, searches using a recording table or searches motion events (see below for more details).
-  **Go To:** Displays the first or last recorded image, or searches by date and time (see below for more details).
-  **Export:** Copies a video segment and saves it (see below for more details).
-  **Camera Menu**





- **Zoom:** Selecting *Zoom* and choosing the camera number zooms the current playback image of the selected camera on the screen. Selecting the  (*Exit*) icon at the top of the screen by pressing the MENU button on the remote control or moving the mouse pointer to the top of the screen exits the Zoom mode. While in the Zoom mode, the  icon displays on the camera screen if ZOOM is selected in the Display setup screen (OSD tab).
- **Audio:** Selecting *Audio* while in the full-screen mode toggles playing recorded audio On and Off. While playing recorded audio, the  icon displays on the camera screen if Audio is selected in the Display setup screen (OSD tab).
- **Enable De-Interlace:** Selecting *Enable De-Interlace* while in the full-screen mode turns the de-interlace filter on.

**NOTE:** The video signal has a time difference of 1/60 second between odd and even fields because it is composed of 60 interlaced fields per second. When recording video with Very High (D1) resolution, video is made up of frame units combining two fields – one odd field and one even field. This can cause horizontal scan lines or flashes in areas with motion because of the time difference between the two fields. Turning on the de-interlace filter provides clearer video by eliminating these horizontal scan lines and flashes.

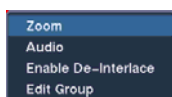
**NOTE:** The Camera Menu also can be displayed by clicking the right mouse button on each camera screen.



- **Edit Group:** Selecting *Edit Group* supports the active cameo function. (8-ch model only) Select *Edit Group* and choose a camera that you want to change the display position (e.g., Camera A). Then, click the right mouse button to display the menu. If you choose another camera in the menu (e.g., Camera B), the screen displays Camera B instead of Camera A. Clicking the right mouse button and selecting *Exit Group Edit* in the menu exits the Active Cameo mode.

-  **Alarm:** Resets the DVR's outputs including the internal buzzer during an alarm. Selecting the  icon is the same as pressing the ALARM button on the remote control.

**!** **Panic:** Starts panic recording of all cameras. Selecting **!** again stops panic recording. It is the same as pressing the PANIC button on the remote control.

**↶** **Exit:** Exits the Search mode and enters the Live Monitoring mode.

## SEARCH

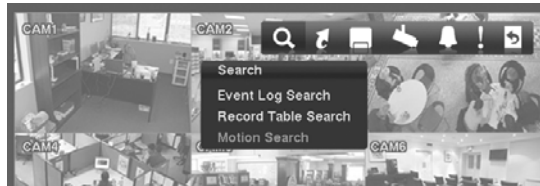

### Event Log Search

| Time                   | Type         | Title      |
|------------------------|--------------|------------|
| 05/11/2010 07:02:02 PM | Video Loss 7 | CAM7       |
| 05/11/2010 07:02:01 PM | Video Loss 6 | CAM6       |
| 05/11/2010 07:01:49 PM | Alarm-In 5   | Alarm-In 5 |
| 05/11/2010 07:01:49 PM | Alarm-In 6   | Alarm-In 6 |
| 05/11/2010 07:01:48 PM | Alarm-In 6   | Alarm-In 6 |
| 05/11/2010 07:01:48 PM | Alarm-In 5   | Alarm-In 5 |
| 05/11/2010 07:01:45 PM | Motion 1     | CAM1       |
| 05/11/2010 07:01:44 PM | Motion 2     | CAM2       |
| 05/11/2010 07:01:34 PM | Motion 6     | CAM6       |
| 05/11/2010 07:01:33 PM | Motion 5     | CAM5       |

Option... Close

The DVR maintains a log of each time the Alarm Input port is activated. The Event Log Search screen displays this list. Use the arrow buttons to highlight the event for which you would like to see video.

Pressing the **↶** button will select the event video and display the first image of the event. Pressing the **⏮** (Play/Pause) button on the remote control button will start playing the “event” video segment. If you want to return to live monitoring, press the MENU button on the remote control and select the **↶** (Exit) icon at the top of the screen.

**NOTE:** It is possible no recorded image displays on the current screen. Press the **LAYOUT** button on the remote control and change the screen mode to 3x3 for the 8-channel DVR and 2x2 for the 4-channel DVR. You will be able to easily see which cameras have recorded video for target time.

You also can narrow your event search by selecting Option... and setting up the new search condition.



- **From:** Pressing the **↶** button toggles between On and Off. When set to Off, you can enter a specific Date and Time. When set to On, the search will be from the first recorded image.
- **To:** Pressing the **↶** button toggles between On and Off. When set to Off, you can enter a specific Date and Time. When set to On, the search will be to the last recorded image.

- **Check Time Overlap:** Selecting the box and pressing the **↶** button toggles between On and Off. You will be able to turn the Check Time Overlap on or off only if user-defined date and time have been set in the From and To boxes. If the DVR’s date and time have been reset, it is possible for the DVR to have overlapping start and stop times. When set to On, you will be asked to select one of the overlapping start and stop times. When set to Off, the DVR will display search results from all start times to all stop times.
- **Alarm-In:** Select the alarm inputs that you want to include in your search.
- **Motion:** Select the cameras for which you want any reports of motion detection.
- **Video Loss:** Select the cameras for which you want any reports of lost video.
- **Panic Record, Check Recording, Check Alarm-In, Disk Almost Full, Disk Bad, Disk Temperature, Disk S.M.A.R.T., Fan Error:** Pressing the **↶** button toggles between On and Off to include or exclude self-diagnostic events as part of your search.

Once you set your desired search conditions, select **Search** and press the  button to display the search results in the Event Log Search screen. Selecting **Cancel** exits the screen without saving the changes.

## Record Table Search

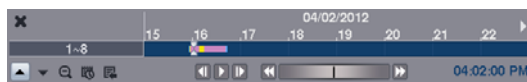

Standard View

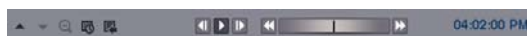

Compact View











Expanded View

Recording information about video images currently displayed on the screen displays in the recording status bar. A grey vertical line indicates the current search position. To search for specific video, move the vertical line by pressing the **Left** or **Right** arrow buttons on the remote control, scrolling the mouse wheel or clicking the mouse on the desired segment.

If the DVR's time and date have been reset to a time that is earlier than some recorded video, it is possible for the DVR to have more than one video stream in the same time range. In this case, the overlapping time range in the record table will be separated by a yellow vertical line.

**NOTE: The recorded data in the time range located to the right of the yellow vertical line is the latest.**

There are three view modes; Standard view, Expanded view and Compact view. Standard view (default) displays combined recording information of all camera channels currently displayed on the screen. In the Standard view mode, selecting the  icon located at the bottom switches to the Expanded view mode. The Expanded view displays the recording information of each camera channel currently displayed on the screen. Selecting the  icon switches to the Compact view mode which displays only the toolbar. Selecting the  icon in the Compact view mode switches to the Standard view mode, and selecting the  icon in the Expanded view mode switches to the Standard view mode.

Selecting  or  located at the bottom zooms the record table. Selecting  displays eight hours (1-minute based), and selecting  displays 24 hours (3-minute based) at once. To move to earlier or later times that are not shown in the current record table screen, select the arrows located at the end of the times by using the arrow buttons on the remote control.

**NOTE: If the DVR has images recorded in more than one recording mode in the same time range, the recording status bar displays recording information in the following priority order: Panic → Pre-Event → Event → Time. The color of the bar indicates different recording modes: Red for Panic, Yellow for Pre-Event, Purple for Event, and Blue for Time.**

Selecting  located at the bottom displays the Calendar Search screen.



Days with recorded video display on the calendar with white numbers. You can select the days with recorded video by using the arrow buttons on the remote control. Selecting the **Display when entering Search Mode** box will display the Calendar Search screen whenever entering the Search mode. Once you have selected a day, pressing the  button displays the first recorded image of the selected date on the screen. Once you have selected the date you want to search, review the surrounding video by using the playback controls located at the bottom. Refer to the *Recording Video – Playing Recorded Video* section of this chapter for information regarding playback controls.

Selecting  located at the bottom displays the Search menu.

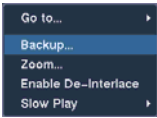

- **Go To:** Displays the first or last recorded image, or searches by date and time (see below for more details).
- **Backup:** Copies a video segment and saves it (see below for more details).
- **Zoom:** Zooms the current playback image.
- **Enable De-Interlace:** Turns the de-interlace filter on.
- **Slow Play:** Plays video at low speed (x1/2, x1/3, x1/4, x1/6 and x1/8).

**NOTE: Playing video at low speed will be supported for video recorded 10 images or more per second.**

Selecting **X** in the top-left corner exits the Record Table Search screen.

### Motion Search

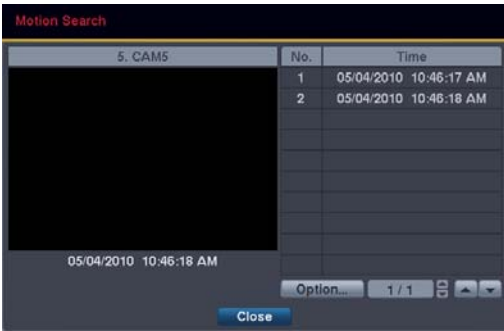

Motion Search can be selected from the Search menu while the DVR displays the camera full screen. The Motion Search screen displays a list of motion events. Use the arrow buttons to highlight the event for which you would like to see video and press the **[Enter]** button to display the video associated with the selected event in the small search screen.

Selecting **Close** and pressing the **[Enter]** button will extract the video associated with the Motion event and display the first image of the event. Pressing the **[Play/Pause]** button on the remote control button will start playing the “event” video segment. If you want to return to live monitoring, press the **MENU** button on the remote control and select the **[Exit]** icon at the top of the screen.

You also can narrow your event search by selecting **Option...** and setting up new search conditions.



- **From:** Pressing the **[Enter]** button toggles between On and Off. When set to Off, you can enter a specific Date and Time. When set to On, the search will be from the first recorded image.
- **To:** Pressing the **[Enter]** button to toggles between On and Off. When set to Off, you can enter a specific Date and Time. When set to On, the search will be to the last recorded image.

- **Zone:** Press the **[Enter]** button, and an image from the video appears with a grid overlay. You can turn sensor blocks On and Off to define the area of the picture in which you want to search for motion. The zone should be placed or focused on the centre or, at least, within the outline of targeted object.

**NOTE: Defining the area of the image in which you want to search for motion is nearly identical to setting up the DVR for Motion Detection. Please refer to the Motion Event Settings section in Chapter 2 — Installation & Configuration – Advanced Setup, Event Setup for more detailed instructions on setting up the detection blocks.**

- **Sensitivity:** Select the sensitivity from 1 (low sensitivity) to 5 (high sensitivity).
- **Min. Blocks:** Set the number of sensor blocks that must be activated.

Once you set your desired search conditions, select **Search** and press the **[Enter]** button to display the search results in the Motion Search screen. Selecting **Cancel** exits the screen without saving the changes.

When you search for motion events for another camera, you will be asked whether or not you want to delete the previous search results from the list.

## GO TO

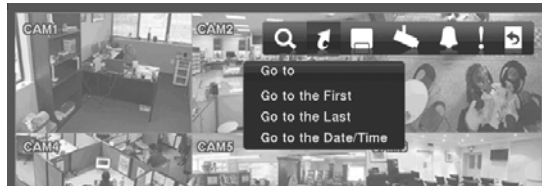

### Go to the First

Selecting *Go to the First* displays the first recorded image.

### Go to the Last

Selecting *Go to the Last* displays the last recorded image.

### Go to the Date/Time

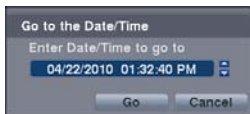

You can use the **Left** and **Right** arrow buttons on the remote control to select the year, month, day, hours, minutes and seconds. Use the **Up** and **Down** arrow buttons to change to the date and time you want to search for video. Once you have set the date and time, press the **Enter** button. Then select **GO** and press the **Enter** button to display the image recorded at the selected time. The **Playback** buttons on the remote control can now be used to review the surrounding video. (If no video was recorded during the selected time, a message appears alerting you that no image was recorded at that time.)

## EXPORT

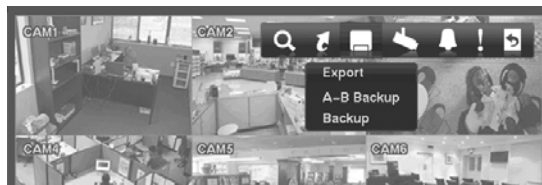

### A–B Backup

Selecting *A–B Backup* or pressing the **BACK UP** button on the remote control during playback will set the starting point of the video to be clip copied, and the **AB** icon displays at the bottom-left corner of the screen. Selecting *A–B Backup* or pressing the **BACK UP** button again will set the ending point of the video to be clip copied and displays the **Backup** screen.

### Backup

Select *Backup* or press the **BACK UP** button on the remote control while in the **Search** mode or **Live Monitoring** mode, and the **Backup** screen appears to allow backup setup.

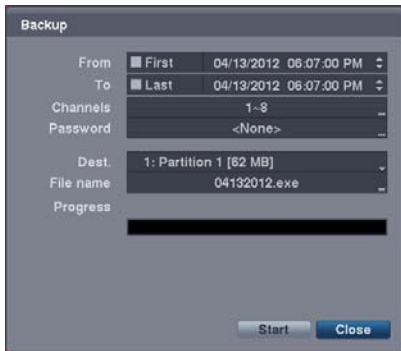

- **From:** Pressing the button toggles between On and Off. When set to Off, you can enter a specific Date and Time. When set to On, the copy will be from the first recorded image.
- **To:** Pressing the button toggles between On and Off. When set to Off, you can enter a specific Date and Time. When set to On, the copy will be to the last recorded image.
- **Channels:** Select the cameras that you would like to include in your video clip.
- **Password:** Pressing the button displays a virtual keyboard allowing you to enter a password for reviewing the video clips.
- **Dest.:** Select the storage device on which you would like to record the video clip.



**CAUTION: The USB device for backup must be FAT 16 or FAT32 format.**

- **File name:** The DVR automatically assigns a file name to the video clip. However, you can give the video clip file a different name. Pressing the button displays a virtual keyboard. Enter a file name for the video you are copying and select Close. The DVR will automatically add “.exe” to the file name.

**NOTE: When naming a file, you cannot use the following characters: \, /, :, \*, ?, “, <, >, |.**

Once you have given the video clip a file name, select **Start** and press the button. A confirmation screen displaying data size will appear. When the storage device does not have enough space, the DVR will ask if you want to copy as much of the video clip as possible in the available space. Select **Continue** and press the button to continue backup.

Once the backup starts, you can cancel it by selecting **Stop** or hide the screen by selecting **Close**. When selecting **Close**, Backup continues and a confirmation screen displays when complete.

**NOTE: The file size for backup is limited to 30GB. When backing up video clips larger than 2GB, the video clips will be save in units of 2GB. For example, 3 individual 2GB files will be created when saving a 6GB video clip.**

You can use other functions on the DVR while video is being copied. To do this, select **Close** and press the button. You can return to the **Backup** screen at any time to check the progress.

You do not need to install any special software on your personal computer to review the video clips. Refer to the REVO Remote Pro manual for instructions on how to review video clips you have copied.

**NOTE: During Backup, you cannot shut the system down or clear data on the storage device.**



**CAUTION: Do NOT disconnect the USB flash drive from the DVR while backing up video.**

## REVO REMOTE

REVO Remote allows you to access a remote DVR, monitor live video images and search recorded video using Internet Explorer web browser anytime from virtually anywhere.

Computer system requirements for using the REVO Remote program are:

- Operating System: Microsoft® Windows® XP x86 (32 Bit) (Service Pack 3), Microsoft® Windows® Vista x86 (32 Bit) (Service Pack 1), Microsoft® Windows® 7 x86 (32 Bit)
- CPU: Intel Pentium III (Celeron) 600MHz or faster
- RAM: 128MB or higher
- VGA: 8MB or higher (1024x768, 24bpp or higher)
- Internet Explorer: Version 6.0 or later

Start Internet Explorer on your local PC. You can run the REVO Remote program by entering the following information in the address field.

- “http://IP address:port number” (The DVR IP address and the REVO Remote port number (default: 12088) set in the Network setup screen (General tab))
- Or, “http://www.revodvr.com/DVR name” (The DVR name registered on the DVRNS server)

**NOTE:** You will need to get the appropriate IP address for the DVR you want to connect to and the REVO Remote port number from your network administrator.

**NOTE:** REVO Remote only works with Microsoft Internet Explorer and will NOT work with other browsers.

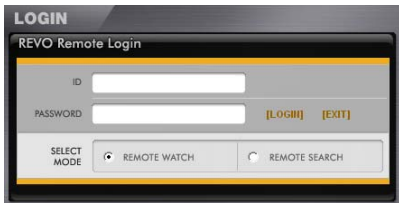

Select between the REMOTE WATCH (Web monitoring) and REMOTE SEARCH (Web search) modes. Entering ID (default: admin) and PASSWORD, and clicking the [LOGIN] button logs in using the selected mode.

You will need to enter the DVR IP address in the DVR ADDRESS field when running the REVO Remote program by entering http://www.revodvr.com. Selecting the Use DVRNS option allows you to enter the DVR name registered on the DVRNS server instead of the IP address. You must enter the DVRNS server address and port number in the SETUP setting when selecting the Use DVRNS option.

**NOTE:** Do NOT close the LOGIN window during the REVO Remote operation, otherwise, it will cause a script error when switching between Web monitoring and Web search modes, and you will need to restart the REVO Remote program.

**NOTE:** When running the updated REVO Remote for the first time, Internet Explorer might occasionally load the information of the previous version. In this case, delete the temporary internet files by selecting Tools → Internet Options → General tab, and then run REVO Remote again.

**NOTE:** There might be a problem that the bottom of REVO Remote page is cropped due to the address or status bars in Microsoft Internet Explorer 7.0. In this situation, it is recommended that websites open windows without address or status bars by changing the internet setting. (Go to the Tools → Internet Options → Security tab → Click the Custom level... button → Select *Enable* for the *Allow websites to open windows without address or status bars* option)

**NOTE:** When running REVO Remote in the Microsoft Windows Vista or higher operating system, it is recommended to start Internet Explorer with elevated administrator permissions. Click the right mouse button on the Internet Explorer icon and select the *Run as administrator* option from the context menu. Otherwise, some functions of the REVO Remote might be limited.

**NOTE:** There might be a problem with screen display or screen update due to low image transmission speed when using the Microsoft Windows Vista or higher operating system. In this situation, it is recommended that you disable the Auto Tuning capability of your computer.

Run the *Command Prompt* with elevated administrator permissions (Go to the Start Menu → Accessories → Command Prompt → Click the right mouse button and select the *Run as administrator* option). Then enter “netsh int tcp set global autotuninglevel=disable” and press the enter key. Restart your computer to apply the changes.

If you want to enable the Auto Tuning capability again, enter “netsh int tcp set global autotuninglevel=normal” after running the Command Prompt with elevated administrator permissions. Restart your computer to apply the changes.

## WEB MONITORING

Remote Watch is a remote web monitoring program that allows you to monitor live video transmitted in real-time from the remote DVR.



- ① Click the icon to log out of the REVO Remote program
- ② Click the icon to access the web search mode.
- ③ Position the mouse pointer on the Remote Watch logo to see the version number of the REVO Remote program.
- ④ The DVR information window displays the login information of REVO Remote.
- ⑤ Click the screen format to select the desired display mode. When changing the screen format, the selected camera on the current screen will be located in the first cell of the new layout.
- ⑥ Click the camera button to select the camera to be viewed.
- ⑦ Click the icon to adjust the brightness, contrast, saturation and hue of the monitored image.
- ⑧ Click the icon to pan, tilt and zoom the remote site camera.
- ⑨ Click the icon to control alarm out devices at the remote site.

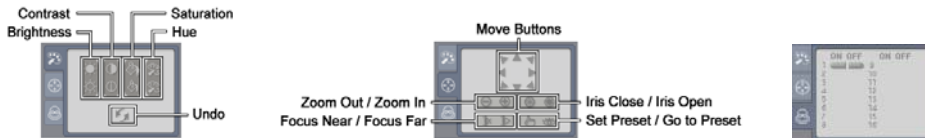

- ⑩ Click the icon to save the current image in a bitmap or JPEG file format.
- ⑪ Click the icon to set up the image drawing mode and OSD. You can adjust the display speed by changing the image drawing mode, and select OSD.
- ⑫ The event status window at the bottom displays a list of events that were detected at the remote site.
- ⑬ Selecting a camera on the screen and clicking the right mouse button displays the text menu screen.



- **Change Camera Title:** Changes the camera name.
- **Enable Audio:** Enables audio communication with the remote site. When the audio control panel displays, click the icon to send audio to the connected remote site and click the button again to stop sending audio. Click the icon to monitor live audio from the connected remote site through the attached speaker and click the button again stop monitoring live audio. Clicking both the and buttons allows two-way communication. Clicking the button disables audio communication.
- **Aspect Ratio:** Changes the image aspect ratio.
- **Deinterlacing:** Using a deinterlace filter for interlaced video enhances image display quality by eliminating horizontal scan lines and noise in areas with motion.
- **Anti-Aliasing Screen:** Enhances image display quality by eliminating stair stepping (aliasing) effects in the enlarged image.

**NOTE:** A camera name change in the Web Watch mode does not affect the camera name set up on the remote site. Leaving the Camera Title blank causes the camera name set up on the remote site to display.















**NOTE:** The  icon will display on each camera screen when audio communication is available between the REVO Remote system and a DVR.

## WEB SEARCH

Remote Search is a remote web search program that allows you to search recorded video on the remote DVR.

**NOTE:** The remote site connection in the Web Search mode will automatically be disconnected if there is no activity for 30 minutes.



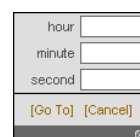

- ① Click the  icon to log out of the REVO Remote program.
  - ② Click the  icon to access the web monitoring mode.
  - ③ Position the mouse pointer on the Remote Search logo to see the version of the REVO Remote program.
  - ④ The DVR information window displays the time information of recorded data on the remote DVR and login information of REVO Remote.
  - ⑤ Click the  icon to blur, sharpen, equalize and interpolate playback images. Click the   icons to zoom out or zoom in the recorded image. Click the   icons to adjust the brightness of the recorded images.
- NOTE: Image processing works only in the pause mode.**
- ⑥ The playback function buttons include fast backward, pause, play, fast forward, go to the first image, go to the previous image, go to the next image, and got to the last image.
  - ⑦ Click the screen format to select the desired display mode.
  - ⑧ Click the  icon to enter the time-lapse search mode which allows you to search for recorded data by time and then play back images found within the time parameters. The Timetable window located at the bottom displays the time information for the image of the date selected on the calendar. If there is more than one video stream in the same time range, you can select the video stream you want to search. Clicking a specific time displays the image recorded at that time on the screen. Selecting the  icon allows you to display an image from a specific time.
  - ⑨ Click the  icon to enter the event search mode which allows you to search for event log entries using specific conditions and play back the images associated with those event entries.
  - ⑩ Click the  icon to save the current image in a bitmap or JPEG file format, or click the  icon to save any video clip of recorded data as an executable file. Click the  icon to print the current image on a printer connected to your computer.



**NOTE:** When saving as an executable file, selecting the *Exclude Player* option will reduce the file size and its saving time. You can download the Player program to review the video clip by entering the following information in the address field of Internet Explorer.

- When using the DVRNS: “http://www.revodvr.com/DVR Name/REVOBackup.exe” (The DVR name registered on the DVRNS server)
- When not using the DVRNS: “http://IP address:port number/REVOBackup.exe” (The DVR IP address and the REVO Remote port number (default: 12088) set in the Network setup screen (General tab))

- ⑪ Click the  icon to set up the image drawing mode and OSD display. You can adjust the display speed by changing the image drawing mode, and select OSD information to be displayed on the screen.
- ⑫ Click the  icon to reload the recording data.
- ⑬ The Timetable displays recorded data of the selected camera by time (in hour segments).
- ⑭ Selecting a camera on the screen and clicking the right mouse button displays the text menu screen.

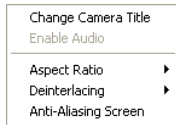

- Change Camera Title: Changes the camera name.
- Aspect Ratio: Changes the image aspect ratio.
- Deinterlacing: Using a deinterlace filter for interlaced video enhances image display quality by eliminating horizontal scan lines and noise in areas with motion.
- Anti-Aliasing Screen: Enhances image display quality by eliminating stair stepping (aliasing) effects in the enlarged image.





**NOTE:** A camera name change in the Web Search mode does not affect the camera name set up on the remote site. Leaving the Camera Title blank causes the camera name set up on the remote site to display.

# Appendix

## ERROR CODE NOTICES

| SYSTEM UPGRADE RELATED |   | BACKUP RELATED |                                 |
|------------------------|---|----------------|---------------------------------|
| No.                    | Description                                       | No.            | Description                     |
| 0                      | Unknown error.                                    | 0              | Unknown error.                  |
| 1                      | File version error.                               | 1              | Device error.                   |
| 2                      | Operating system version error.                   | 2              | Mounting failed.                |
| 3                      | Software version error.                           | 5              | File already existed.           |
| 4                      | Kernel version error.                             | 6              | Not enough space.               |
| 100                    | Upgrade device mounting failed.                   | 7              | Creating temporary file failed. |
| 101                    | Package is not found.                             | 8              | Opening disk failed.            |
| 102                    | Extracting package failed.                        | 9              | Formatting disk failed.         |
| 103                    | LILLO failed.                                     | 10             | Database has been changed.      |
| 104                    | Rebooting failed.                                 | 11             | Appending failed.               |
| 105                    | Invalid package.                                  | 12             | Bad sector.                     |
| 300                    | Remote connection failed.                         | 13             | No executable file.             |
| 301                    | Remote network error.                             | 14             | Opening executable file failed. |
| 302                    | Remote upgrade is not authorized.                 | 15             | Writing executable file failed. |
| 303                    | Saving remote package failed.                     | 16             | Creating image failed.          |
| 304                    | Remote upgrade is cancelled by the user.          |                |                                 |
| 400                    | USB device mounting failed.                       |                |                                 |
| 401                    | Reading upgrade package on the USB device failed. |                |                                 |
| 402                    | Copying upgrade package on the USB device failed. |                |                                 |
| 500                    | System is busy clip copying.                      |                |                                 |





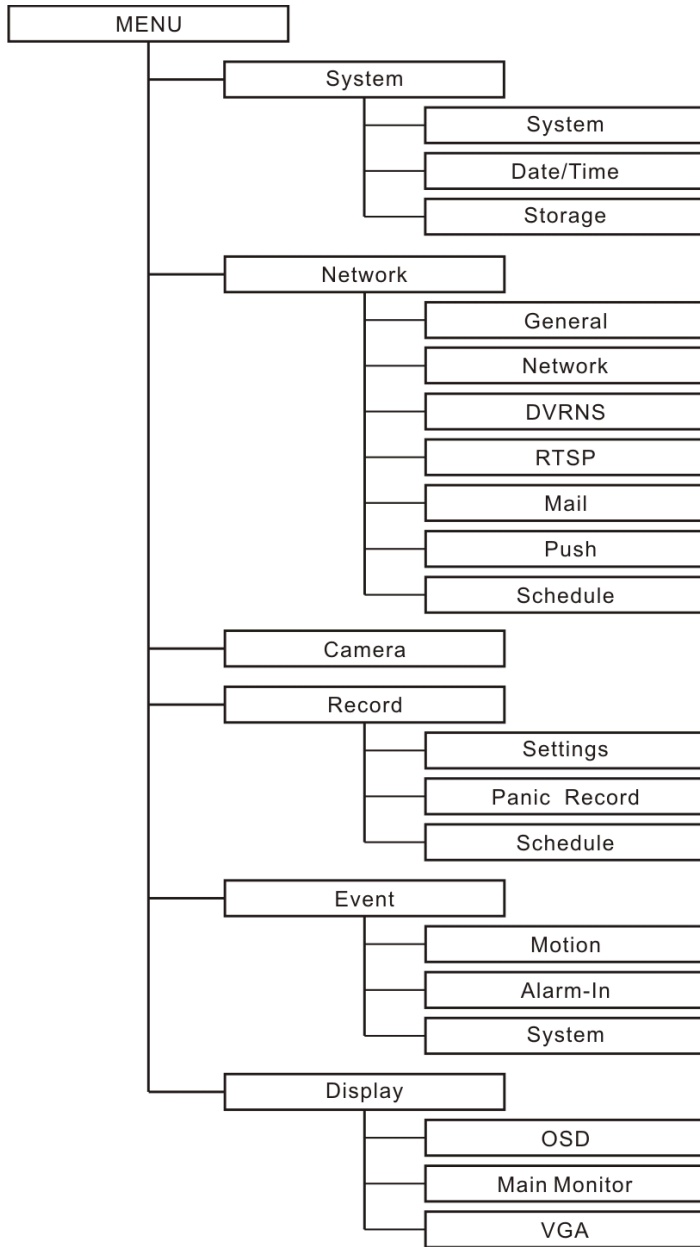

## TROUBLESHOOTING

| PROBLEM   | POSSIBLE SOLUTION   |
|---|---|
| No Power  | <ul style="list-style-type: none"> <li>• Check power cord connections.</li> <li>• Confirm that there is power at the outlet.</li> </ul>   |
| No Live Video   | <ul style="list-style-type: none"> <li>• Check camera video cable and connections.</li> <li>• Check monitor video cable and connections.</li> <li>• Confirm that the camera has power.</li> <li>• Check camera lens settings.</li> </ul>  |
| DVR has stopped recording.  | If hard disk drive is full, you will either need to delete video or set the DVR to the Recycle On (Recycle When Disk Full) Mode. See <i>Chapter 2 – Installation &amp; Configuration, Advanced Setup – Record Setup</i> for details.  |
| The  icon displays, however, the DVR is not recording. | When the DVR is in the Pre-Event recording mode, the yellow  and  icons display when there is no event, and the DVR is not recording. The red  and  icons display when any event occurs and the DVR starts recording. |
| IR remote control does not work properly.   | <ul style="list-style-type: none"> <li>• Check the batteries in the remote control.</li> <li>• Check that nothing blocks the infrared sensor on the DVR.</li> <li>• Check the system ID setting for the remote control. See <i>Chapter 2 – Installation &amp; Configuration, Advanced Setup – System Setup</i> for details.</li> </ul>  |
| While upgrading the system, the DVR keeps rebooting and the upgrade fails.  | If the current system version is higher than the upgrade package file version, you should reset the DVR first using the Factory Reset. When using the Factory Reset, you will lose any settings you have saved.   |

# MAP OF SCREENS (ADVANCED SETUP)



## SPECIFICATIONS

| VIDEO  |   |
|--|---|
| Signal Format                                | NTSC  |
| Video Input                                  | 4 or 8 RJ-12 inputs, 1 Vp-p, auto-terminating, 75 Ohms  |
| Monitor Outputs                              | Composite: One (RCA), 1 Vp-p, 75 Ohms<br>VGA: One   |
| Video Resolution                             | Composite: 720x480<br>VGA: 800x600@60Hz, 1024x768@60Hz, 1280x1024@60Hz  |
| Playback/Record Speed<br>(images per second) | 8-ch Model   240/240ips (NTSC)<br>4-ch Model   120/120ips (NTSC)  |
| INPUTS/OUTPUTS                               |   |
| Alarm Input                                  | 4 or 8 TTL, NC/NO programmable, 4.3V (NC) or 0.3V (NO) threshold  |
| Alarm Output                                 | 1 relay out, terminal block, NO, 1A @ 30VDC   |
| Internal Buzzer                              | 80dB at 10cm  |
| Network Connectivity                         | 10/100 Base Ethernet  |
| Audio Input                                  | RJ-12 Input: 4 or 8 Line In   |
| Audio Output                                 | RCA Output: 1, Line Out   |
| IR Port                                      | 1 Remote Control  |
| CONNECTORS                                   |   |
| Video Input                                  | 4 or 8 RJ-12 (12V  , Max. 310mA)   |
| Monitor Output                               | Composite: 1 RCA<br>VGA: 1 DB15   |
| Audio In                                     | RJ-12 connector   |
| Audio Out                                    | 1 RCA connector   |
| Alarms                                       | Terminal block  |
| Ethernet Port                                | RJ-45   |
| RS-485 Serial Port                           | Terminal block, telemetry control   |
| USB Port                                     | 2 on front panel (2.0)  |
| STORAGE                                      |   |
| Primary Storage                              | SATA hard disk drive  |
| Backup Storage                               | USB flash drive   |
| GENERAL                                      |   |
| Dimensions (W x H x D)                       | 10.4" x 2.0" x 7.4" (265mm x 52mm x 188mm)  |
| Unit Weight                                  | 3.7 lbs. (1.7kg)  |
| Shipping Weight                              | 7.3 lbs. (3.3kg)  |
| Shipping Dimensions<br>(W x H x D)           | 14.2" x 4.7" x 18.1" (360mm x 120mm x 460mm)  |
| Operating Temperature                        | 41°F to 104°F (5°C to 40°C)   |
| Operating Humidity                           | 0% to 90%   |
| Power  | 8-ch Model   DVR: 12V  , 1.2A (Adaptor: 100-240 V~, 50/60Hz, 1.5A, 12V  , 5A)<br>Camera: 12V  , 2.5A (Adaptor: 100-240 V~, 50/60Hz, 1.5A, 12V  , 5A)<br>4-ch Model   DVR & Camera: 12V  , 2.2A (Adaptor: 100-240 V~, 50/60Hz, 1.5A, 12V  , 5A |
| Power Consumption                            | 8-ch Model   DVR: Max. 20W, Camera: Max. 40W<br>4-ch Model   DVR: Max. 35W  |
| Approval                                     | FCC   |



# Index

|  |        |
|--|--------|
| <b>A</b>                               |        |
| Active Cameo Mode .....                | 32     |
| ADSL .....                             | 18     |
| Advanced Schedule Mode .....           | 23     |
| Advanced Setup .....                   | 13     |
| Alarm .....                            | 30     |
| Alarm Button .....                     | 9      |
| Alarm Out .....                        | 25     |
| Alarm-In Event Setting .....           | 25     |
| Anti-Aliasing Screen .....             | 42     |
| Arrow Buttons .....                    | 8      |
| Aspect Ratio .....                     | 42     |
| Audio .....                            | 30     |
| Audio Out .....                        | 4      |
| <b>B</b>                               |        |
| Back Up Button .....                   | 9      |
| Backup .....                           | 38     |
| Basic Schedule Mode .....              | 23     |
| Buzzer .....                           | 25     |
| <b>C</b>                               |        |
| Calendar Button .....                  | 9      |
| Camera Buttons .....                   | 7      |
| Camera Setup .....                     | 21     |
| Camera Title .....                     | 21     |
| Cat5 Cable .....                       | 5      |
| Change Password .....                  | 16     |
| Check Alarm-In .....                   | 26     |
| Check Recording .....                  | 26     |
| Check Time Overlap .....               | 36     |
| Color Control .....                    | 30     |
| Color of the Bar .....                 | 37     |
| <b>D</b>                               |        |
| Date/Time Setting .....                | 16     |
| Daytime .....                          | 24     |
| DHCP .....                             | 18     |
| Disk Almost Full .....                 | 26     |
| Disk Bad .....                         | 16, 26 |
| Disk Temperature .....                 | 26     |
| DNS .....                              | 12     |
| DNS Server .....                       | 18     |
| DSL/PPPoE .....                        | 12     |
| DVRNS (DVR Name Service) .....         | 19     |
| Dwell .....                            | 23     |
| <b>E</b>                               |        |
| Enable De-Interlace .....              | 35     |
| Enable SSL for Transferring Data ..... | 17     |
| Enter Button .....                     | 8      |
| Event Actions .....                    | 20, 25 |
| Event Log Search .....                 | 36     |
| Event Log Search Screen .....          | 36     |
| Event Monitoring .....                 | 32     |
| Event Monitoring On .....              | 28     |
| Event Setup .....                      | 24     |
| Export .....                           | 15, 35 |
| <b>F</b>                               |        |
| Factory Reset .....                    | 4      |
| FAT16 .....                            | 15     |
| FAT32 .....                            | 15     |
| File Name .....                        | 40     |
| File Size .....                        | 40     |
| Freeze .....                           | 29     |
| Freeze Button .....                    | 7      |
| <b>G</b>                               |        |
| Gateway .....                          | 12     |
| GND (Ground) .....                     | 5      |
| Go To .....                            | 38     |
| <b>H</b>                               |        |
| HDD LED .....                          | 6      |
| <b>I</b>                               |        |
| ID Button .....                        | 7      |
| Import .....                           | 15     |
| Infrared Sensor .....                  | 6      |
| IP Address .....                       | 12     |
| IPS .....                              | 22     |
| <b>L</b>                               |        |
| Layout Button .....                    | 8      |
| Login .....                            | 41     |
| Login/Logout .....                     | 31     |
| <b>M</b>                               |        |
| Mail .....                             | 20     |
| Main Monitor Setting .....             | 27     |
| Manual .....                           | 18     |
| Media Player .....                     | 20     |
| Menu Button .....                      | 8      |
| Min. Blocks .....                      | 24     |
| Motion Detection Zone .....            | 24     |
| Motion Event Setting .....             | 24     |
| Motion Search .....                    | 38     |
| Motion Sensitivity .....               | 24     |
| Mouse .....                            | 34     |
| Mouse Pointer .....                    | 34     |

**N**

NAT ..... 18  
 NC (Normally Closed) ..... 25  
 Network Setup ..... 17  
 Nighttime ..... 24  
 NO (Normally Open) ..... 5, 25  
 Notify ..... 25

**O**

OSD Margin ..... 27  
 OSD Setting ..... 27

**P**

Panic ..... 30  
 Panic Button ..... 8  
 Panic Record ..... 22  
 Playback Buttons ..... 8  
 Port Number Setup ..... 18  
 Post-Event Record Dwell ..... 23  
 Pre-Event Record ..... 23  
 Preset Set ..... 32  
 PTZ ..... 21, 25, 30  
 PTZ Button ..... 8  
 PTZ Control Buttons ..... 9

**Q**

Quick Setup Wizard ..... 10

**R**

RCA Jack ..... 4  
 Record Setup ..... 22  
 Recorded Data ..... 16  
 Recycle On, Recycle Off ..... 33  
 Recycle When Disk Full ..... 22  
 Remote Search ..... 41, 43  
 Remote Watch ..... 41  
 Resolution ..... 22  
 RJ-12 ..... 4  
 RS-485 ..... 5  
 RTP ..... 19  
 RTSP ..... 19

**S**

S.M.A.R.T. .... 16  
 Search Mode ..... 30  
 Sequence ..... 29  
 Sequence Button ..... 7  
 Setup ..... 30  
 Setup Import ..... 15  
 Show System Log ..... 15

Slow Play ..... 38  
 SMTP Server ..... 18, 20  
 Standard (CIF), High (Half D1), Very High (D1) ..... 33  
 Storage Setting ..... 16  
 Subnet Mask ..... 12  
 System Event Setting ..... 26  
 System ID ..... 15  
 System Setup ..... 14  
 System Shutdown ..... 16

**T**

Transfer Speed ..... 17  
 Transparency ..... 27  
 TX-/RX- ..... 5  
 TX+/RX+ ..... 5

**U**

Upgrade ..... 15  
 UPnP (Universal Plug and Play) ..... 18  
 USB Flash Drive ..... 15  
 USB Port ..... 6

**V**

Version ..... 15  
 VGA ..... 4  
 VGA Setting ..... 28  
 Virtual Keyboard ..... 13

**Z**

Zoom ..... 30, 38  
 Zoom Button ..... 8