

**600TV Lines
Super High
Resolution
Color Camera**

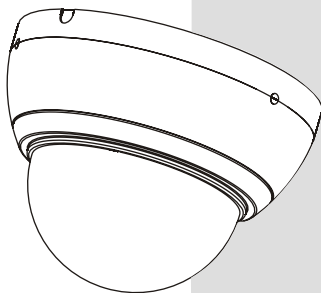

3-AXIS PLASTIC DOME CAMERA

*Please read this manual thoroughly before use, and keep it handy for future reference.
Design and specifications are subject to change without notice.*

WARNING

TO REDUCE THE RISK OF FIRE OR ELECTRIC SHOCK, DO NOT EXPOSE THIS PRODUCT TO RAIN OR MOISTURE. DO NOT INSERT ANY METALLIC OBJECTS THROUGH THE VENTILATION GRILLS OR OTHER OPENINGS ON THE EQUIPMENT.

CAUTION

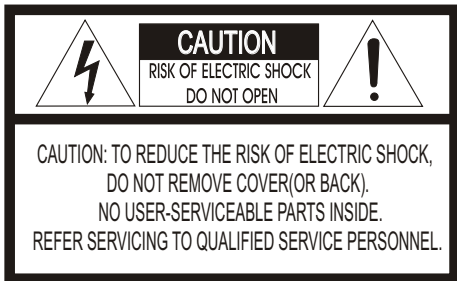

EXPLANATION OF GRAPHICAL SYMBOLS



The lightning flash with arrowhead symbol, within an equilateral triangle, is intended to alert the user to the presence of uninsulated "dangerous voltage" within the product's enclosure that may be of sufficient magnitude to constitute a risk of electric shock to persons.



The exclamation point within an equilateral triangle is intended to alert the user to the presence of important operating and maintenance (servicing) instructions in the literature accompanying the product.

PRECAUTIONS

Safety -----

Should any liquid or solid object fall into the cabinet, unplug the unit and have it checked by the qualified personnel before operating it any further.

Unplug the unit from the wall outlet if it is not going to be used for several days or more. To disconnect the cord, pull it out by the plug. Never pull the cord itself.

Allow adequate air circulation to prevent internal heat build-up. Do not place the unit on surfaces (rugs, blankets, etc.) or near materials (curtains, draperies) that may block the ventilation holes.

Height and vertical linearity controls located at the rear panel are for special adjustments by qualified personnel only.

Installation -----

Do not install the unit in an extremely hot or humid place or in a place subject to excessive dust, mechanical vibration.

Cleaning -----

Clean the unit with a slightly damp soft cloth. Use a mild household detergent. Never use strong solvents such as thinner or benzene as they might damage the finish of the unit.

Retain the original carton and packing materials for safe transport of this unit in the future.

FCC COMPLIANCE STATEMENT

FCC INFORMATION : THIS EQUIPMENT HAS BEEN TESTED AND FOUND TO COMPLY WITH THE LIMITS FOR A CLASS A DIGITAL DEVICE, PURSUANT TO PART 15 OF THE FCC RULES. THESE LIMITS ARE DESIGNED TO PROVIDE REASONABLE PROTECTION AGAINST HARMFUL INTERFERENCE WHEN THE EQUIPMENT IS OPERATED IN A COMMERCIAL ENVIRONMENT. THIS EQUIPMENT GENERATES, USES, AND CAN RADIATE RADIO FREQUENCY ENERGY AND IF NOT INSTALLED AND USED IN ACCORDANCE WITH THE INSTRUCTION MANUAL, MAY CAUSE HARMFUL INTERFERENCE TO RADIO COMMUNICATIONS. OPERATION OF THIS EQUIPMENT IN A RESIDENTIAL AREA IS LIKELY TO CAUSE HARMFUL INTERFERENCE IN WHICH CASE THE USER WILL BE REQUIRED TO CORRECT THE INTERFERENCE AT HIS OWN EXPENSE.

CAUTION : CHANGES OR MODIFICATIONS NOT EXPRESSLY APPROVED BY THE PARTY RESPONSIBLE FOR COMPLIANCE COULD VOID THE USER'S AUTHORITY TO OPERATE THE EQUIPMENT.

THIS CLASS A DIGITAL APPARATUS COMPLIES WITH CANADIAN ICES-003.

CET APPAREIL NUMÉRIQUE DE LA CLASSE A EST CONFORME À LA NORME NMB-003 DU CANADA.

CE COMPLIANCE STATEMENT

WARNING

THIS IS A CLASS A PRODUCT. IN A DOMESTIC ENVIRONMENT THIS PRODUCT MAY CAUSE RADIO INTERFERENCE IN WHICH CASE THE USER MAY BE REQUIRED TO TAKE ADEQUATE MEASURES.

IMPORTANT SAFETY INSTRUCTIONS

1. Read these instructions.
 2. Keep these instructions.
 3. Heed all warnings.
 4. Follow all instructions.
 5. Do not use this apparatus near water.
 6. Clean only with dry cloth.
 7. Do not block any ventilation openings. Install in accordance with the manufacturer's instructions.
 8. Do not install near any heat sources such as radiators, heat registers, stoves, or other apparatus (including amplifiers) that produce heat.
 9. Do not defeat the safety purpose of the polarized or grounding-type plug. A polarized plug has two blades with one wider than the other. A grounding type plug has two blades and a third grounding prong. The wide blade or the third prong are provided for your safety. If the provided plug does not fit into your outlet, consult an electrician for replacement of the obsolete outlet.
 10. Protect the power cord from being walked on or pinched particularly at plugs, convenience receptacles, and the point where they exit from the apparatus.
 11. Only use attachments/accessories specified by the manufacturer.
 12. Use only with the cart, stand, tripod, bracket, or table specified by the manufacturer, or sold with the apparatus.
When a cart is used, use caution when moving the cart/apparatus combination to avoid injury from tip-over.
- 
13. Unplug this apparatus during lightning storms or when unused for long periods of time.
 14. Refer all servicing to qualified service personnel. Servicing is required when the apparatus has been damaged in any way, such as power-supply cord or plug is damaged, liquid has been moisture, does not operate normally, or has been dropped.
 15. **CAUTION THESE SERVICING INSTRUCTIONS ARE FOR USE BY QUALIFIED SERVICE PERSONNEL ONLY. TO REDUCE THE RISK OF ELECTRIC SHOCK DO NOT PERFORM ANY SERVICING OTHER THAN THAT CONTAINED IN THE OPERATING INSTRUCTIONS UNLESS YOU ARE QUALIFIED TO DO SO.**
 16. Use satisfy clause 2.5 of IEC60950-1/UL60950-1 or Certified/Listed Class 2 power source only.

INTRODUCTION

The camera provides high-quality images using Sony CCD technology especially designed for closed-circuit television (CCTV) and security surveillance applications.

Features:

- High resolution and high performance Sony® Super HAD™ II Technology
 - Excellent picture quality
 - 600 lines(Color) of resolution
 - 0.1 lux(Color), 0.04lux(B/W) @ F1.2 50IRE Sensitivity
 - Auto electronic shutter [1/60(1/50) ~ 1/100,000] and manual electronic shutter modes
 - OSD (On Screen Display)
 - Auto and manual white balance modes
 - DWDR
 - OSD Font Color (16 Color)
 - BLC (Back Light Compensation)
 - Day&Night (Auto / DAY / NIGHT / EXT)
 - Private Mask (8 position, 16 Colors)
 - AGC (Auto Gain Control)
 - MIRROR (ON/OFF)
 - VIDEO OUT BNC
 - Motion Detection(4 point)
 - HLC (High Light Compensation)
 - DPC (Dead Pixel Cancellation)
 - 2.8~12mm A/I Varifocal Lens F1.2(D&N Lens option)
 - 9~22mm A/I Varifocal Lens F1.4 (D&N Lens option)
 - 4-9mm A/I Varifocal Lens F1.6 (D&N Lens option)
 - Operates in AC24V +/- 10% / DC12V +/- 10%
 - Use Certified / Listed Class 2 power source only
- Test monitor Output



IMPORTANT : The user of this camera is responsible for checking and complying with local, state, and federal laws and statutes concerning the recording and monitoring of audio signals.

CAMERA CONNECTIONS

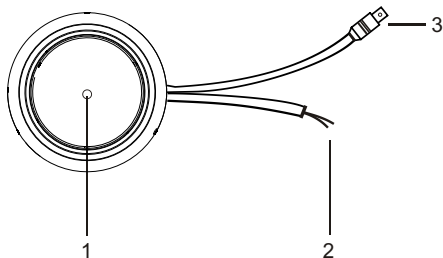

- 1. Lens :** A/I Vari-focal lens for wide area monitoring. (D&N with ICR model option)
- 2. Power :** 24V AC input / 12V DC input
power source from a DC 12V or AC 24V ac +/-10% 60/50Hz +/-1Hz
Use Certified/Listed Class 2 power source only.
*If using DC 12V power adaptor,
use a power supply capable of supplying 5 Watts.
- 3. Video :** BNC connector used to connect the camera to a monitor, switcher, etc.



REMINDER:

Never aim the camera directly into the sun.

CONTENTS of PACKAGE

The package contains the following.

Camera in Housing.....	1
Instruction Manual (This Document).....	1
Accessory Kit for Installing.....	1
Drilling guide label.....	1

BASE INSTALLATION

1. Make mounting holes and cable hole in the place (ceiling or wall) to which this dome camera is installed using the Drilling guide label.

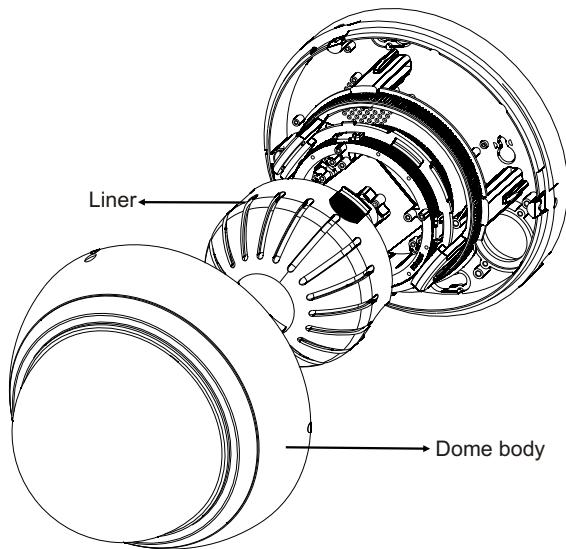

2. To remove dome cover, turn the dome body counterclockwise until locators reach end of travel and pull off.
Push the liner on the sides where the patterns are put in the teeth of a comb and pull it out.

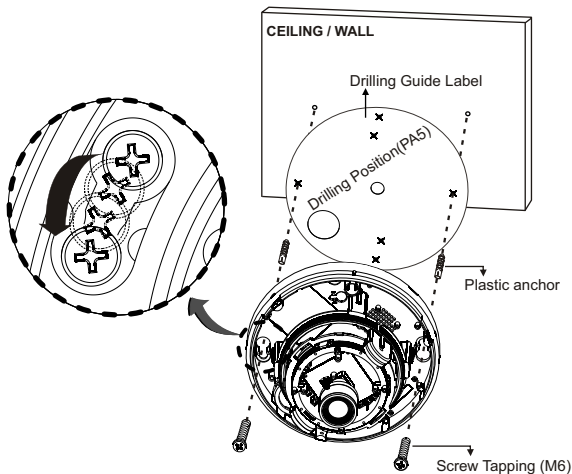

3. Attach the housing to the ceiling using suitable fasteners, M6x35 tapping screws are supplied only use if they are suitable.
Turn the housing to right direction about 16 degrees to lock in place.
4. The assembly of the dome body and liner is in reverse order of disassembly.
Finally, lock dome body with locking screw(M3X5) from the accessory kit.

- Video out check -

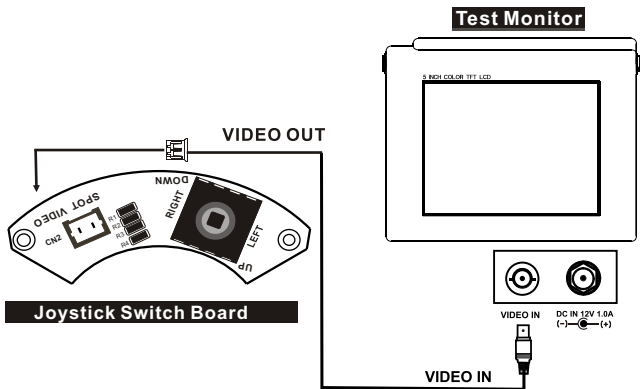

STRUCTURE OF THE SETUP MENU

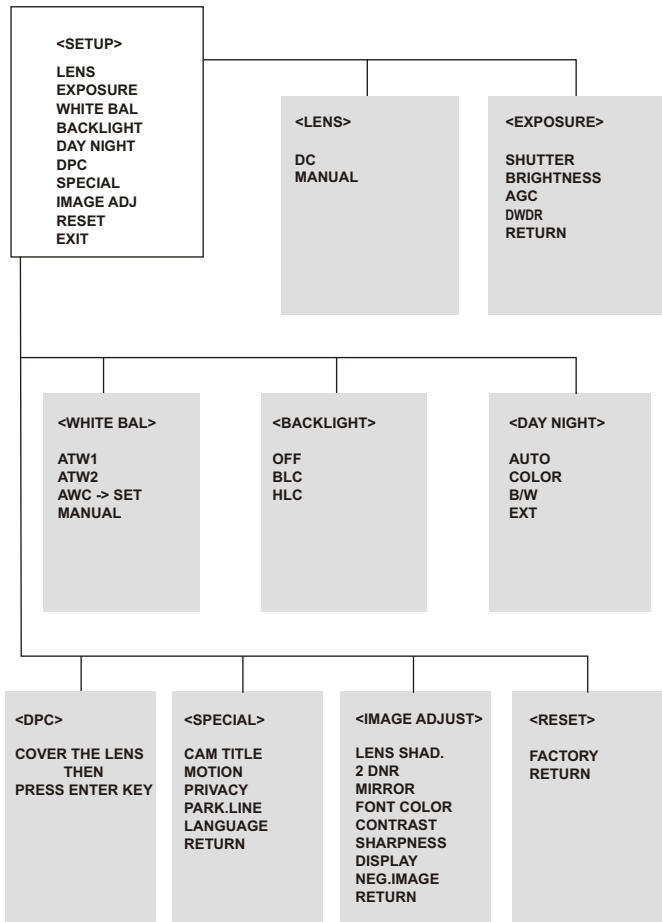

LENS (Selection)

This function is used to adjust the brightness of the screen.

1. When the SETUP menu is displayed on the screen, please position the arrow to point to 'LENS' by using the UP and DOWN buttons.
2. Please select the type of the lens you wish to use by pressing the LEFT or RIGHT button.

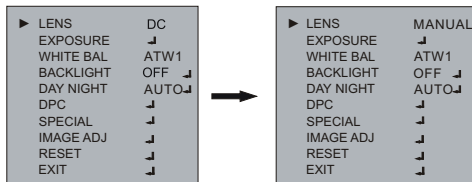

Note The brightness of the screen can be adjusted in DC mode.

EXPOSURE

The EXPOSURE menu is used to set the automatic light control method for this camera.

- 1) SHUTTER** Select the shutter mode.(Auto,1/60(50), FLK~ 1/100,000 sec)
Can be changed while in shutter mode.
- 2) BRIGHTNESS** Adjust BRIGHTNESS level (0 ~ 255)
Can be adjusted while in DC/ manual lens mode.
- 3) AGC** Auto gain control (OFF / LOW / MIDDLE / HIGH)
- 4) DWDR** Digital Wide dynamic range(Xtended Dynamic Range)
OFF / ON

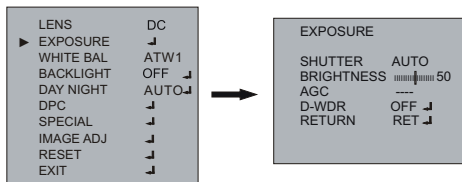

WHITE BAL

The screen color can be adjusted by using the WHITE BALANCE function.

- 1) **ATW1** Set the color temperature 2500°K 10000°K
- 2) **ATW2** Set the color temperature 2000°K 13000°K
- 3) **AWC -> SET** Please press the ENTER button while the camera is directed at a piece of white paper to obtain the optimum state under current illumination. if the environment including the light source is changed, you have to adjust the white balance again.
- 4) **MANUAL** Manual mode. User can change R and B Gain manually.
 - INDOOR Set the color temperature to 3200°K
 - OUTDOOR Set the color temperature to 6300°K

<WHITE BAL MANUAL MODE>

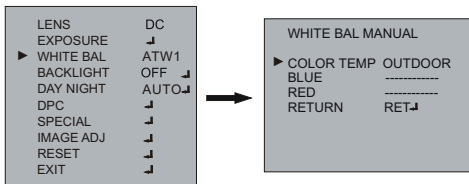

BACKLIGHT

- 1) **BLC** Prevents such a back light effect to secure a clear image under all illumination environments
- 2) **HLC** The function improves the identification capability of subjects facing a brightly lit situation by filtering out the strength of the light

<BACKLIGHT MODE>

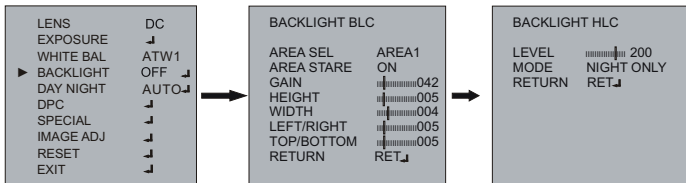

DAY NIGHT

The DAY/NIGHT menu is used to configure the day and night related setting for this camera. This camera can turn the IR(infrared)filter on or off.

Mode : AUTO / COLOR / B/W / EXT (The EXT is not operating in this mode)

<DAY NIGHT AUTO MODE>

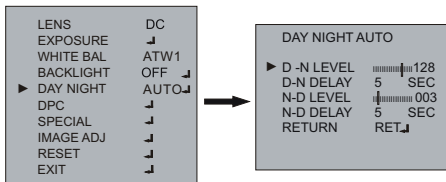

<DAY NIGHT B/W MODE>

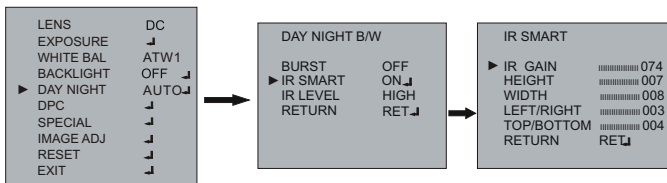

*The IR LEVEL is not operating in DAY NIGHT B/W mode.

DPC

DPC Auto setting (Dead pixels are automatically removed)

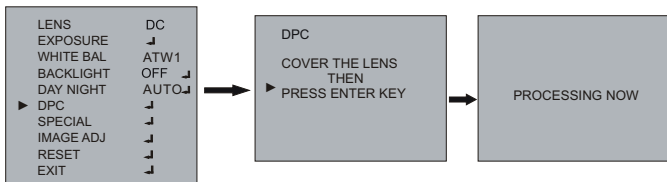

SPECIAL

1) CAM TITLE

A ——— **CAM TITLE**
 0123456789
 ABCDEFGHIJK
 LMNOPQRSTU
B ——— WXYZ ▶→←↑↓()
 ~_#/= & : ~ . , _
C ——— ↔ CLR POS END

A. CAM TITLE

B. Character Table

C. Command Line

← : Move to left

→ : Move to right

CLR : Erase all characters

POS : Move the position of title

END : Save and End

2) MOTION

AREA SELECT

Select MD area number. (AREA1 ~AREA4)

AREA STATE

Select MD ON/OFF

HEIGHT

Adjust height of MD area

WIDTH

Adjust width of MD area

LEFT/RIGHT

Adjust the location of the MD area with boundary LEFT and RIGHT.

TOP/BOTTOM

Adjust the location of the MD area with boundary TOP and BOTTOM

DEGREE

Adjust sensitivity of MD area.(0~255)

VIEW

The screen displays with pink dots. When a motion is detected in the selected area, the pink dots are displayed on the screen.

LENS	DC
EXPOSURE	↓
WHITE BAL	ATW1
BACKLIGHT	OFF ↓
DAY NIGHT	AUTO ↓
DPC	↓
▶ SPECIAL	↓
IMAGE ADJ	↓
RESET	↓
EXIT	↓

SPECIAL	
▶ CAM TITLE	ON ↓
▶ MOTION	ON ↓
PRIVACY	OFF
PARK.LINE	OFF
LANGUAGE	ENGLISH
RETURN	RET ↓

MOTION	
▶ AREA SELECT	AREA1
AREA STATE	ON
HEIGHT	4
WIDTH	4
LEFT/RIGHT	2
TOP/BOTTOM	2
DEGREE	38
VIEW	OFF
RETRURN	RET ↓

3) PRIVACY

- AREA SELECT** Select MASK area number.(Area 1 ~ Area 8)
- AREA STATE** Select MASK ON/OFF
- HEIGHT** Adjust height of MASK area
- WIDTH** Adjust width of MASK area
- LEFT/RIGHT** Adjust the location of the MASK area with boundary LEFT and RIGHT
- TOP/BOTTOM** Adjust the location of the MASK area with boundary TOP and BOTTOM.
- COLOR** Select MASK color. (0~15)
- RETURN**

<PRIVACY MODE>

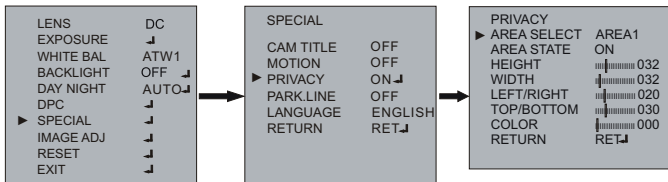

4) PARK.LINE

Select Parking area

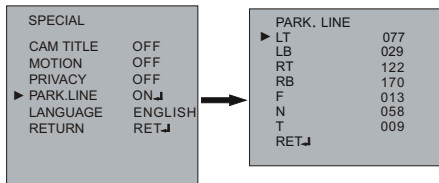

5) LANGUAGE

ENGLISH or CHINESE

6) RETURN

RET

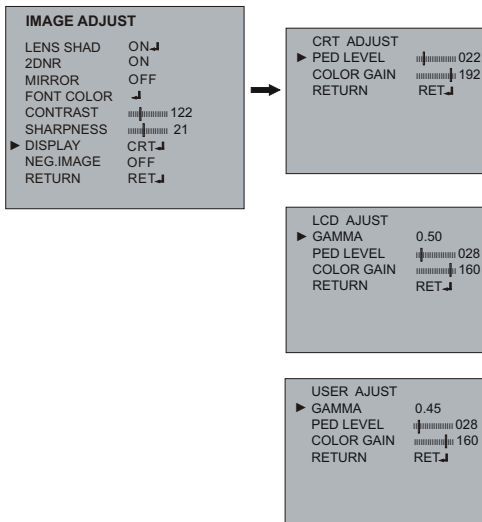

RESET

1) FACTORY

Returns to the level which was set by the manufacturer for shipment.

EXIT

1) EXIT

Saves all settings and exits.

LENS ADJUSTMENT (OPTIONAL VARIFOCAL LENS)

Field of view: Adjust setting from Tele (T) to Wide (W) field of View.

Focus: Adjust lens focus from near (N) to infinity (∞).

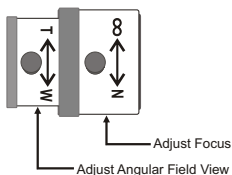

DC AUTO IRIS LENS

	2.8-12mm	9-22mm	4-9mm
Image Size	1/3" CCD	1/3" CCD	1/3" CCD
Focal Length	2.8-12mm $\pm 5\%$	9-22mm $\pm 5\%$	4-9mm $\pm 5\%$
Aperture Ratio	1 : 1.2 $\pm 5\%$	1 : 1.4 $\pm 5\%$	1 : 1.6 $\pm 5\%$
Angular Field of View	DIAGONAL 2.8mm : 119.9° 12mm : 28.80°	DIAGONAL 9mm : 40.2° 22mm : 16.1°	DIAGONAL 4mm : 92.4° 9mm : 39.2°

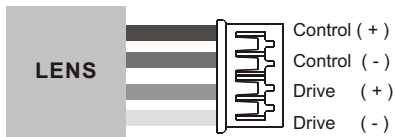

SPECIFICATIONS

MODEL		NTSC	PAL	
Power	Power source	AC24V ± 10% / DC12V ± 10%		
	Power consumption	200mA (2.5 Watts)		
General	Image sensor	1/3" Sony Super HAD CCD II		
	Total pixels	811(H) x 507(V)	795(H) x 595(V)	
	Scanning system	2:1 interface		
	Scanning frequency	15.734KHz(H) x 59.94Hz(V)	15.625KHz(H) x 50Hz(V)	
	Sync. system	Internal		
	Electronic Shutter	1/60 ~ 1/100,000 sec.	1/50 ~ 1/100,000 sec.	
	Resolution	600 TV lines (COLOR)		
	Min. illumination	0.1 Lux(Color), 0.04 Lux(B/W) @ F1.2, 50IRE		
	Video Output	1.0 Vp-p (75 ohm, Composite)		
	S/N Ratio	More than 50dB (AGC off)		
Camera Control	OSD (Joystick Switch)			
F U N C T I O N	Lens	MANUAL / DC		
	Shutter	AUTO, 1/60(1/50), Flickerless, 1/250 ~ 1/100,000sec		
	Brightness	0 ~ 255		
	Backlight	OFF / BLC / HLC(High Light Compensation)		
	AGC	OFF / LOW / MIDDLE / HIGH		
	DWDR	OFF/ON		
	White Balance	ATW1 / ATW2 / AWC->SET / MANUAL		
	Day & Night	AUTO / COLOR / B&W / EXT		
	D&N B/W	Burst	OFF / ON	
		IR Smart	OFF / ON	
		IR Smart Gain	0-255	
	S P E C I A L	Camera Title	OFF / ON	
		Motion Detection	OFF / ON (4 area)	
		Privacy Masking	OFF / ON (8 position)	
		Parking Line	OFF / ON	
		Lens Shading	OFF / ON(0-255)	
		2DNR	OFF / ON	
		Mirror	OFF / ON	
		Font Color	FONT 16 COLOR, ID&TITLE 16 COLOR	
		Contrast	0-255	
		Sharpness	0-31	
		Display	CRT / LCD / USER	
		Nega Image	OFF / ON	
Language	ENGLISH / CHINESE			
DPC	Dead Pixel Cancellation (Auto 64 Points)			
Reset	FACTORY RESET / RETURN			
Connector & etc.	Power input	2-pin wire		
	Video output	BNC connector		
	Lens Mount	Fixed mount		
	Lens	f=2.8~12mm F1.2~360 Varifocal, ICR (D&N) / f=9-22mm F1.4-360 Vafiofocal,ICR (D&N) / f=4-9mm F1.6-360 Varifocal, ICR (D&N)		
	Operating temperature	14°F ~ 122°F (-10°C ~ +50°C)		
	Operating humidity	0 ~ 96% (non-condensing)		
	External Dimension	145(φ) x 114(H) mm		
	Weight	400g		

EXTERNAL DIMENSION

Dimensions

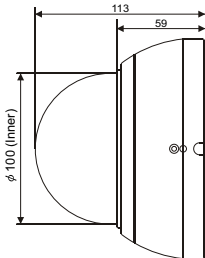
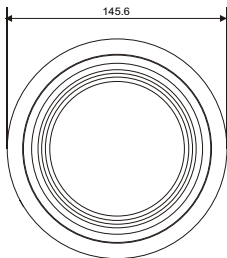

Unit: mm

Window Size	0.1 in. (2.5mm thick), impact-resistant P.C (LEXAN) 3.93 in. (10cm) diameter
Cable Entry	One 1" opening holes
Weight - Unit: Shipping:	0.88 lb. (0.4kg) 1.41 lb. (0.64 kg)

50303061A