

Keyboard Controller



Please read this manual thoroughly before use, and keep it handy for future reference.

WARNING AND CAUTION

WARNING

TO REDUCE THE RISK OF FIRE OR ELECTRIC SHOCK, DO NOT EXPOSE THIS PRODUCT TO RAIN OR MOISTURE. DO NOT INSERT ANY METALLIC OBJECTS THROUGH THE VENTILATION GRILLS OR OTHER OPENINGS ON THE EQUIPMENT.

CAUTION

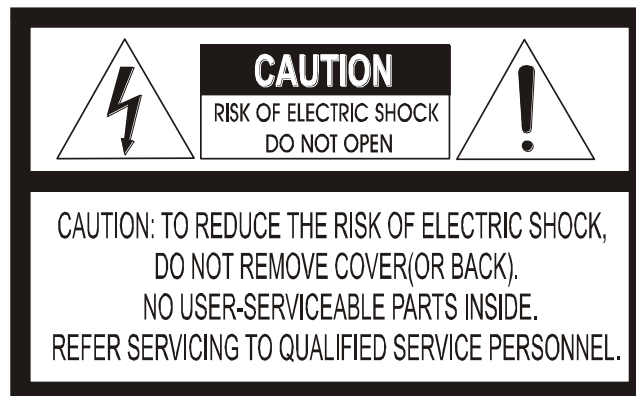

EXPLANATION OF GRAPHICAL SYMBOLS



The lightning flash with arrowhead symbol, within an equilateral triangle, is intended to alert the user to the presence of uninsulated "dangerous voltage" within the product's enclosure that may be of sufficient magnitude to constitute a risk of electric shock to persons.



The exclamation point within an equilateral triangle is intended to alert the user to the presence of important operating and maintenance (servicing) instruction in the literature accompanying the product.

FCC COMPLIANCE STATEMENT

FCC INFORMATION: THIS EQUIPMENT HAS BEEN TESTED AND FOUND TO COMPLY WITH THE LIMITS FOR A CLASS A DIGITAL DEVICE, PURSUANT TO PART 15 OF THE FCC RULES. THESE LIMITS ARE DESIGNED TO PROVIDE REASONABLE PROTECTION AGAINST HARMFUL INTERFERENCE WHEN THE EQUIPMENT IS OPERATED IN A COMMERCIAL ENVIRONMENT. THIS EQUIPMENT GENERATES, USES, AND CAN RADIATE RADIO FREQUENCY ENERGY AND IF NOT INSTALLED AND USED IN ACCORDANCE WITH THE INSTRUCTION MANUAL, MAY CAUSE HARMFUL INTERFERENCE TO RADIO COMMUNICATIONS. OPERATION OF THIS EQUIPMENT IN A RESIDENTIAL AREA IS LIKELY TO CAUSE HARMFUL INTERFERENCE IN WHICH CASE THE USER WILL BE REQUIRED TO CORRECT THE INTERFERENCE AT HIS OWN EXPENSE.

CAUTION: CHANGES OR MODIFICATIONS NOT EXPRESSLY APPROVED BY THE PARTY RESPONSIBLE FOR COMPLIANCE COULD VOID THE USER'S AUTHORITY TO OPERATE THE EQUIPMENT.

THIS CLASS A DIGITAL APPARATUS COMPLIES WITH CANADIAN ICES-003.
CET APPAREIL NUMÉRIQUE DE LA CLASSE A EST CONFORME À LA NORME NMB-003 DU CANADA.

CE COMPLIANCE STATEMENT

WARNING

THIS IS A CLASS A PRODUCT. IN A DOMESTIC ENVIRONMENT THIS PRODUCT MAY CAUSE RADIO INTERFERENCE IN WHICH CASE THE USER MAY BE REQUIRED TO TAKE ADEQUATE MEASURES.

IMPORTANT SAFEGUARDS

1. Read these instructions.
2. Keep these instructions.
3. Heed all warnings.
4. Follow all instructions.
5. Do not use this apparatus near water.
6. Clean only with dry cloth.
7. Do not block any ventilation openings. Install in accordance with the manufacturer's instructions.
8. Do not install near any heat sources such as radiators, heat registers, stoves, or other apparatus (including amplifiers) that product heat.
9. Do not defeat the safety purpose of the polarized or grounding-type plug. A polarized plug has two blades with one wider than the other. A grounding type plug has two blades and a third grounding prong. The wide blade or the third prong is provided for your safety. If the provided plug does not fit into your outlet, consult an electrician for replacement of the obsolete outlet.
10. Protect the power cord from being walked on or pinched particularly at plugs, convenience receptacles, and the point where they exit from the apparatus.
11. Only use attachments/accessories specified by the manufacturer.
12. Unplug this apparatus during lightning storms or when unused for long periods of time.
13. Refer all servicing to qualified service personnel. Servicing is required when the apparatus has been damaged in any way, such as power-supply cord or plug is damaged, liquid has been spilled or objects have fallen into the apparatus, the apparatus has been exposed to rain or moisture, does not operate normally, or has been dropped.
14. CAUTION - THESE SERVICING INSTRUCTIONS ARE FOR USE BY QUALIFIED SERVICE PERSONNEL ONLY. TO REDUCE THE RISK OF ELECTRIC SHOCK DO NOT PERFORM ANY SERVICING OTHER THAN THAT CONTAINED IN THE OPERATING INSTRUCTIONS UNLESS YOU ARE QUALIFIED TO DO SO.
15. Use Certified/Listed Class 2 power supply transformer only.

Table of Contents

Chapter 1 — Introduction	1
1.1 Features	1
1.2 Package Contents	2
1.3 Required Installation Tools	2
1.4 Connectors	2
Chapter 2 — Installation and Configuration	3
2.1 Basic Configuration of Fastrax Dome System	3
2.2 Configuration with DVR	4
2.3 Configuration with MUX	5
2.4 Configuration of Master and Slave Keyboards	6
2.5 Termination	7
2.6 Dip Switch Settings	10
2.7 Multiplexer Configuration	10
Chapter 3 — Keyboard Setup	12
3.1 Configuration	12
Change User Password	12
Change Administrator Password	13
3.2 Network	13
Set Port	13
Set Baud Rate	13
Com Ports	14
MUX Config (Multiplexer Configuration)	14
Set Slave Kbd	17
Slave KBD Unit	17
3.3 Camera	17
3.4 Time / Date	18
3.5 ALARM	18
3.6 LCD	19
3.7 DATA BANK	19
3.8 INITIALIZATION	20
3.9 HOLD TIME	20
Chapter 4 — Slave Keyboard Setup	21
Chapter 5 — Install with DVR Series	22
5.1 Install with Standalone DVR Series	22
5.2 Install with PC DVR Series	24

Chapter 6 — Operation	27
6.1 Keyboard Lock/Unlock (Hidden command)	27
6.2 Controlling Multiplexer	27
6.2.1 Selecting Multiplexer	27
6.2.2 Dome Camera Selection	27
6.3 Summary of Keyboard Controls	28
6.3.1 Keys for Dome camera	29
6.3.2 Keys for Multiplexer	30
6.3.3.1 Keys for DVR [DVR1-4, PC-DVR]	31
6.3.3.2 Example of Key operation in PC-DVR	33
6.4 DVR5 protocol for the DVR for the version 3.1.0 and over	34
Appendix A- Short Cut Key	39
Appendix B- Trouble Shooting	41
Appendix C- OPTIONAL JUNCTION BOX	41
Appendix D -SPECIFICATION	42

Chapter 1 — Introduction

1.1 Features

This keyboard controller is capable of controlling dome cameras and providing remote control functions for a variety of external switching devices such as Multiplexers, Digital Video Recorders etc. A combination of 4 Keyboard controllers and 5 Multiplexers comprises a small matrix system (64x4) using its remote control functions and programmable macro functions.

- Variable speed control joystick with zoom controlling handle.
- Program and recall programmed preset positions, auto scan, tour, pattern, from the selected dome camera.
- Two levels of password are supported for higher security, administrator and user.
- Up to 254 dome cameras controllable including 64 dome cameras with Alarm mode.
- Multiplexers (Max 255) and DVR system (Max 99) can be controlled remotely at each KBD controller regardless Master or Slave.
- Using 3~5 multiplexers and 4 Keyboard controllers, 32~64x4 matrix system can be configured.
- Up to 3 slave of the same type keyboard controllers can be connected to the master keyboard.
- Battery backed-up clock displays real time on the LCD screen.
- Up to two dome cameras' programmed data can be downloaded to nonvolatile memory space, and later uploaded to the new dome camera.
- The dome with the ID up to 3999 can be controlled.
- Scan range option: 32, 254, 3999.

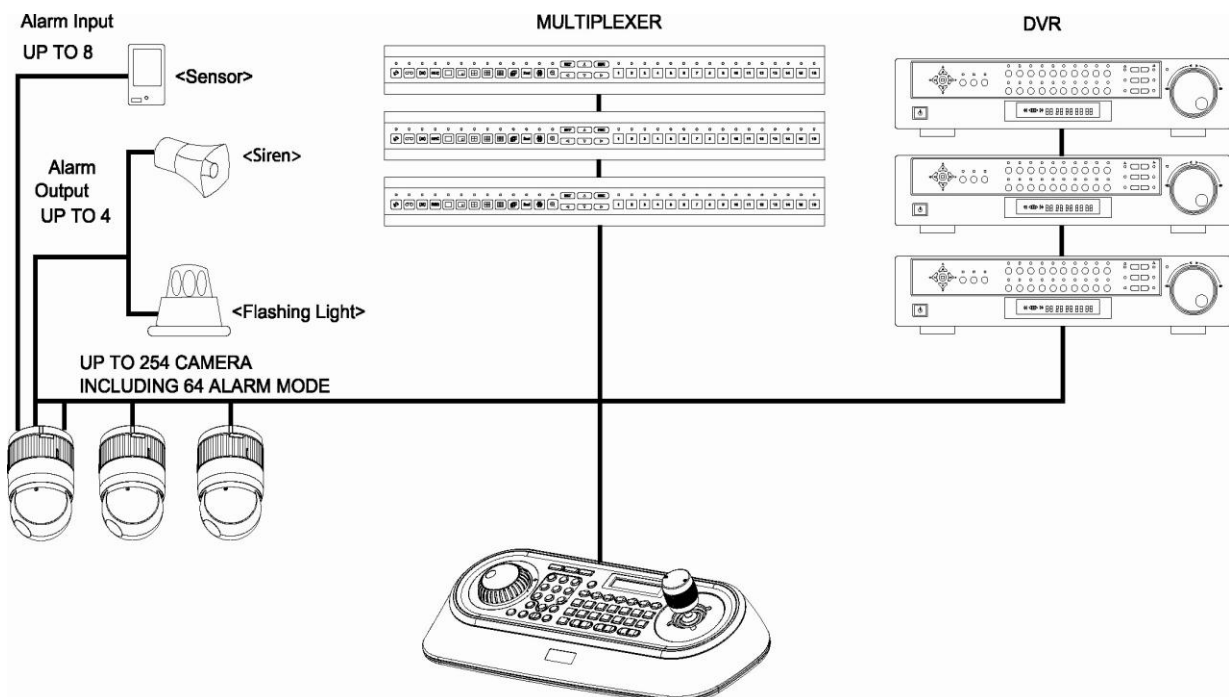

Figure 1 – Typical system Configuration

1.2 Package Contents

The package contains the following.

Description	Q'ty
Keyboard controller	1
Instruction manual	1
12VDC Power supply (SMPS)	1
Power Cord	1

1.3 Required Installation Tools

No special tools are required to install the KBD controller. Refer to the installation manuals for the other items that make up part of your system.

1.4 Connectors

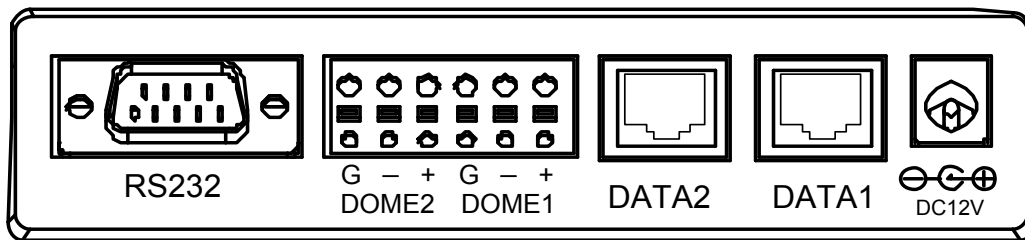

CONNECTOR	USAGE
RS232	RS232:DVR/UPGRADE
DOME2	RS485:DOME/DVR/MULTIPLEXER/SLAVE KEYBOARD
DOME1	RS485:DOME
DATA2	FOR JUNCTION BOX ONLY
DATA1	FOR JUNCTION BOX ONLY
DC12V	FOR POWER SUPPLY

NOTE: DON'T CONNECT THE DATA1 PORT AND DC12V PORT TOGETHER.

Chapter 2 — Installation and Configuration

2.1 Basic Configuration of Fastrax Dome System.

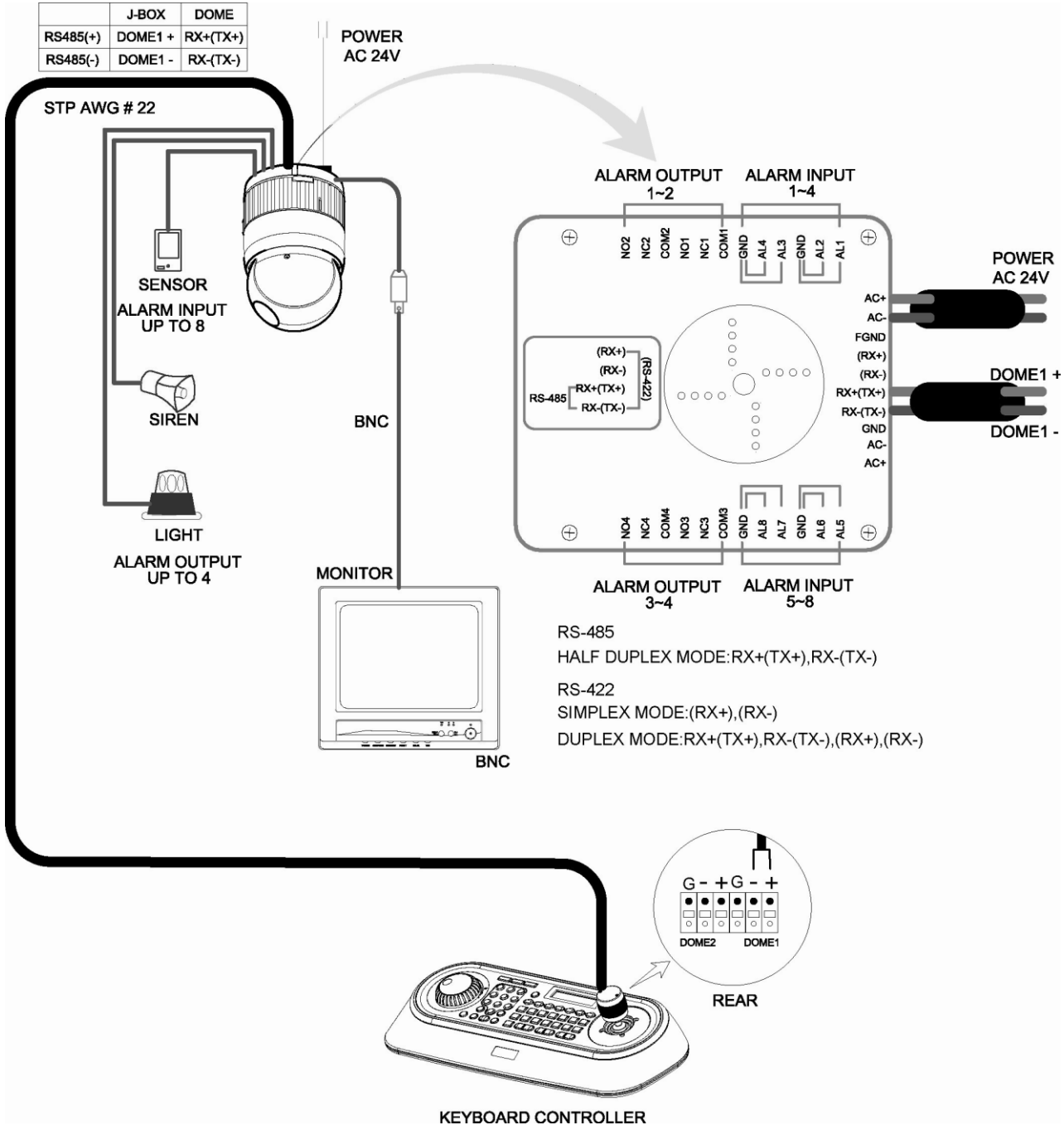

Figure 2 – Basic installation diagram

2.2 Configuration with DVR.

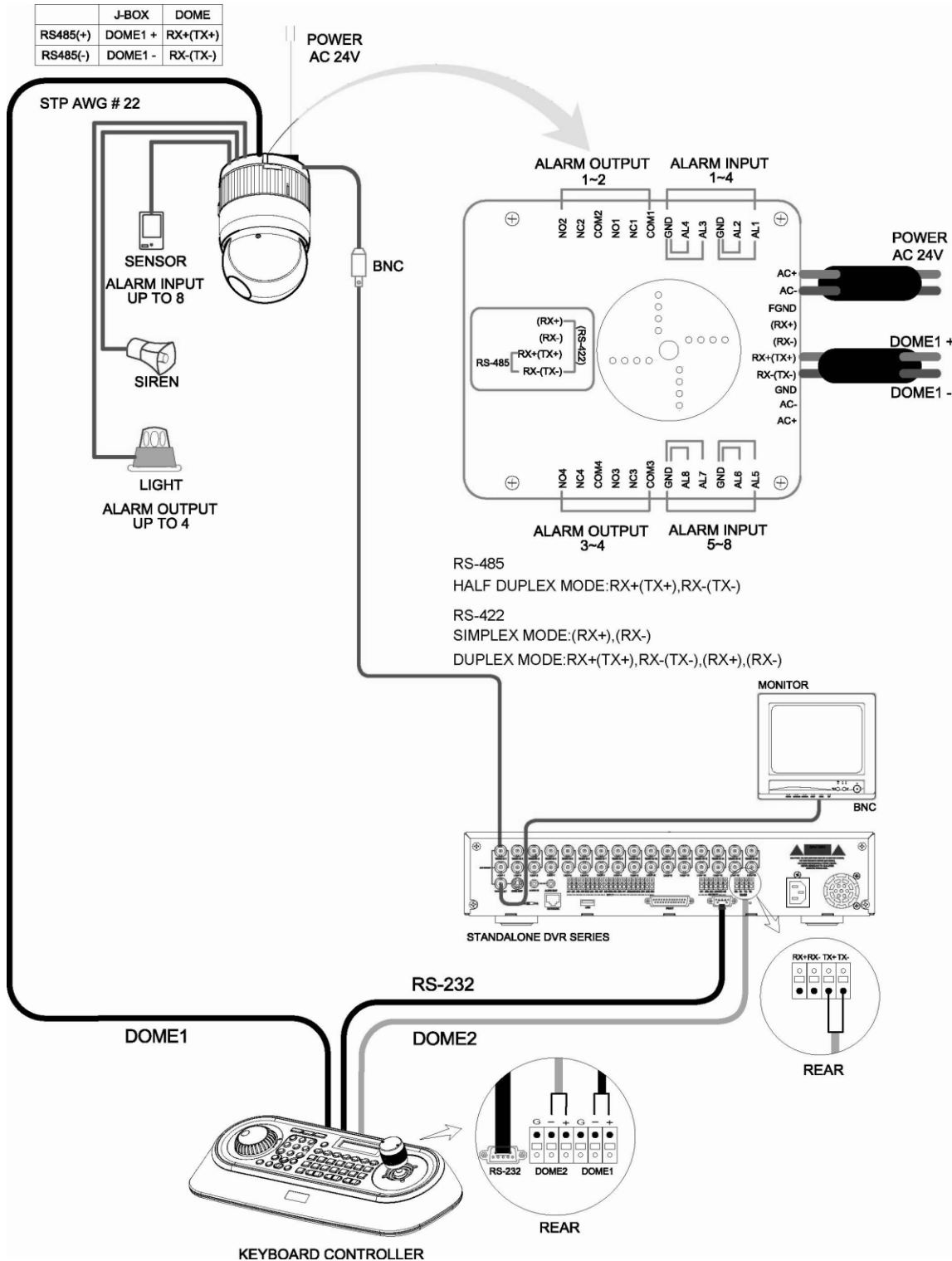

Figure 3 –installation diagram with DVR

2.3 Configuration with MUX.

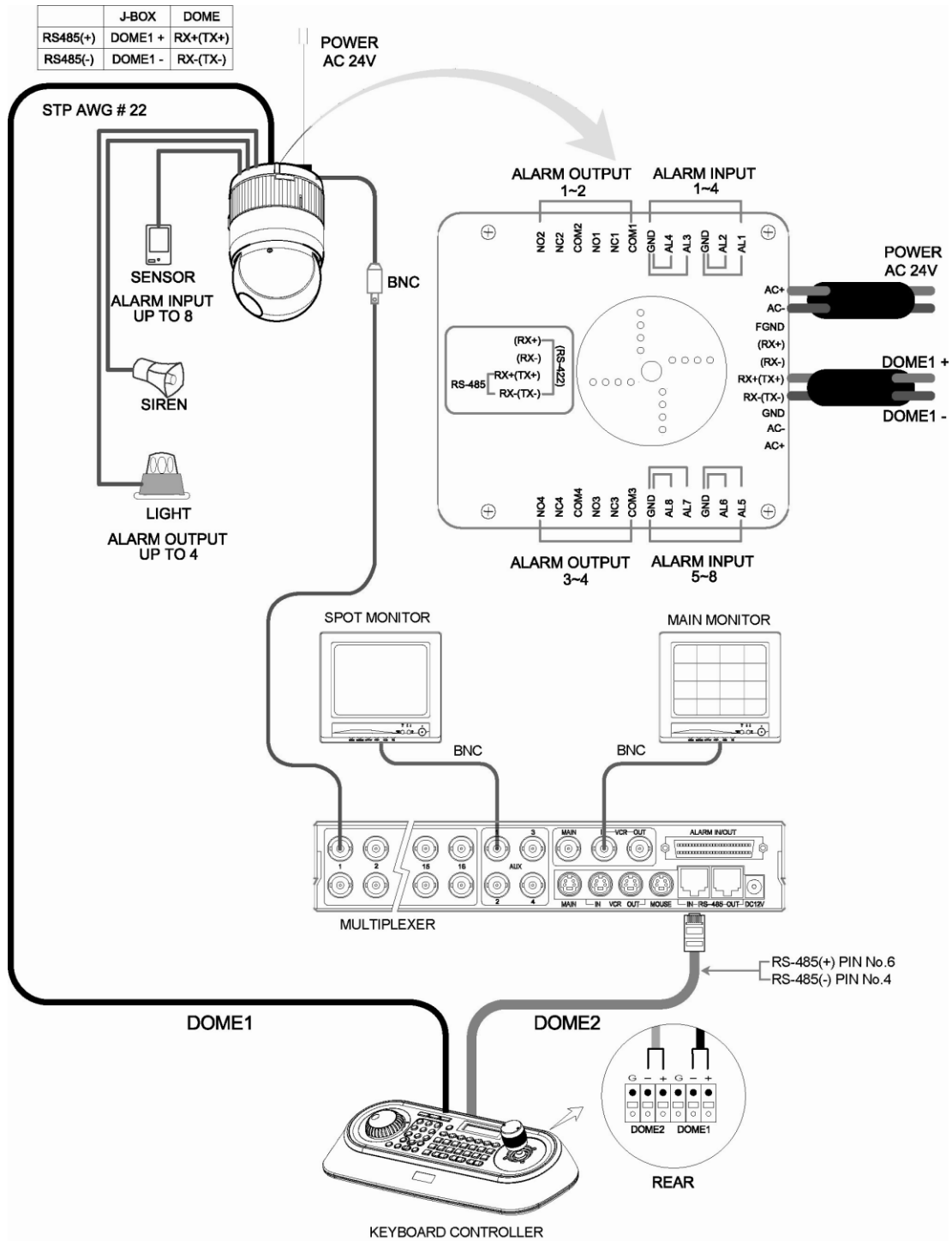

Figure 4 –installation diagram with MUX

2.4 Configuration of Master and Slave Keyboards.

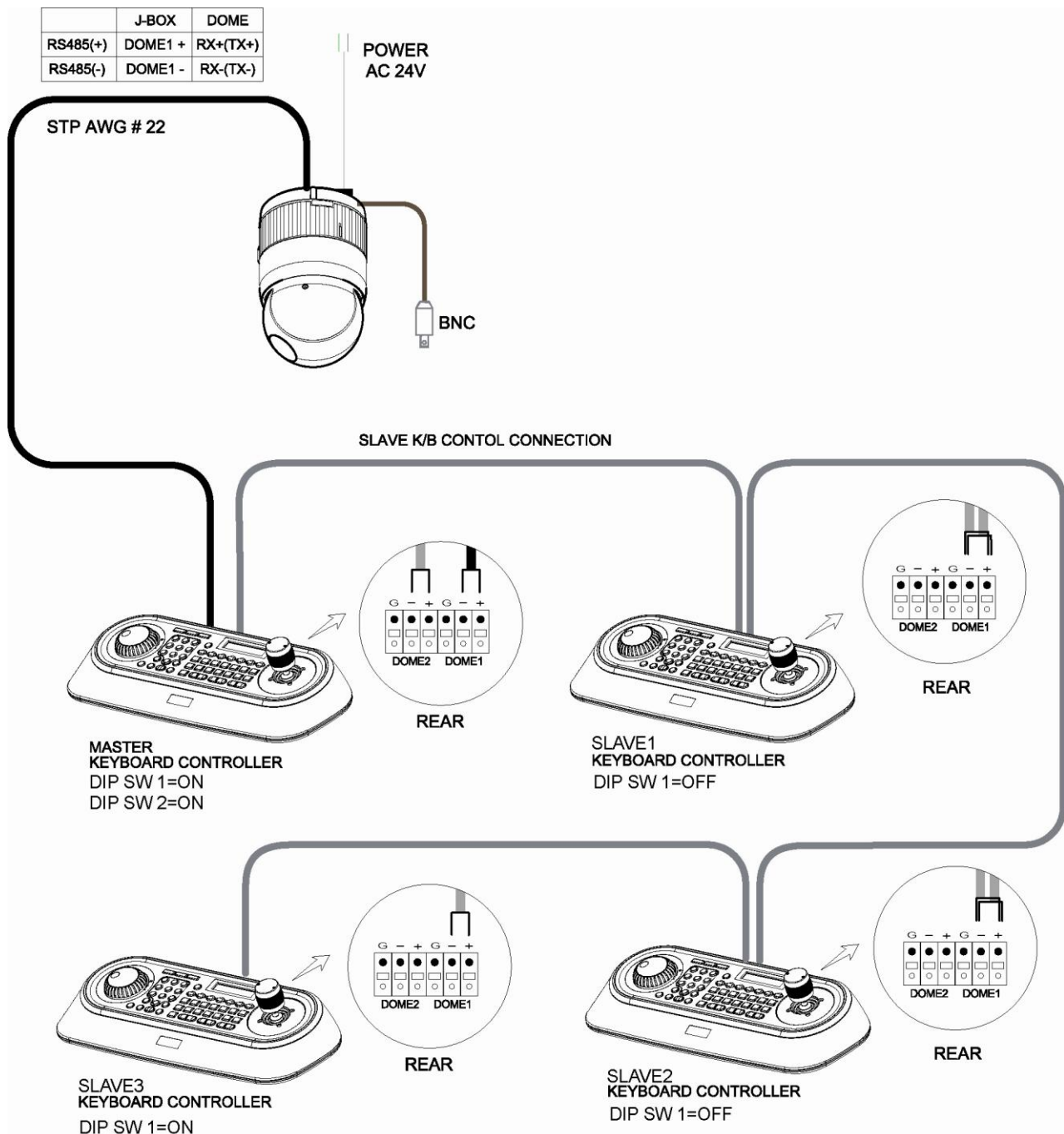

Figure 5 –Master and Slave keyboard connection

Note: Connect the DOME1 port of all slave keyboards to the DOME2 port of the master keyboard and set the DIP SW 1 and 2 as the figure above.

Without J-BOX

Master Keyboard Setting

Slave Keyboard Setting

1.

```
Network
1.J-BOX Set : OFF
2.Set Port
3.MUX Config
4.Set Slave KBD
Save and Exit
```

1. Dip switch the 8th of S1 is "ON"

2.

```
Network
1.J-BOX Set : OFF
2.Keyboard ID : 01
3.BPS:9600
Save and Exit
```

2.

```
Com Ports
1.DOME1 : DOME
2.DOME2 : KBDTRI (or KBDDUP)
3.RS232 : NONE
Save and Exit
```

3.

```
Set Slave Kbd
1.Slave KBD : ON
2.MUX cont : ON
3.DVR cont : ON
4.Dome Menu : ON
5.Slave KBD Unit
Save and Exit
```

4.

```
Slave KBD Unit
1.Slave ID1 : ON
2.Slave ID2 : OFF
3.Slave ID3 : OFF
Save and Exit
```

With J-BOX

Master Keyboard Setting

Slave Keyboard Setting

1.

```
Network
1.J-BOX Set : ON
2.Set Port
3.MUX Config
4.Set Slave KBD
Save and Exit
```

1. Dip switch the 8th of S1 is "ON"

2.

```
Network
1.J-BOX Set : ON
2.Keyboard ID : 01
3.BPS:9600
Save and Exit
```

2.

```
Com Ports
1.DOME1 : DOME
2.D2/DVR : NONE
3.ALARMPC: NONE
4.MUX/KBD: NONE
5.DVR/AUX: NONE
Save and Exit
```

3.

```
Set Slave Kbd
1.slave KBD : ON
2.MUX cont : ON
3.DVR cont : ON
4.Dome Menu : ON
5.slave KBD Unit
Save and Exit
```

4.

```
Slave KBD Unit
1.slave ID1 : ON
2.slave ID2 : OFF
3.slave ID3 : OFF
Save and Exit
```

2.5 Termination.

The first and last devices in an installation (dome and keyboard controller) must have the data line terminated by setting the DIP switch. Without proper termination, there is potential for control signal errors. Total length of the cable for communication should not exceed 4000ft (1.2Km). Refer to Figure 6 for setting the dome camera and keyboard controller termination.

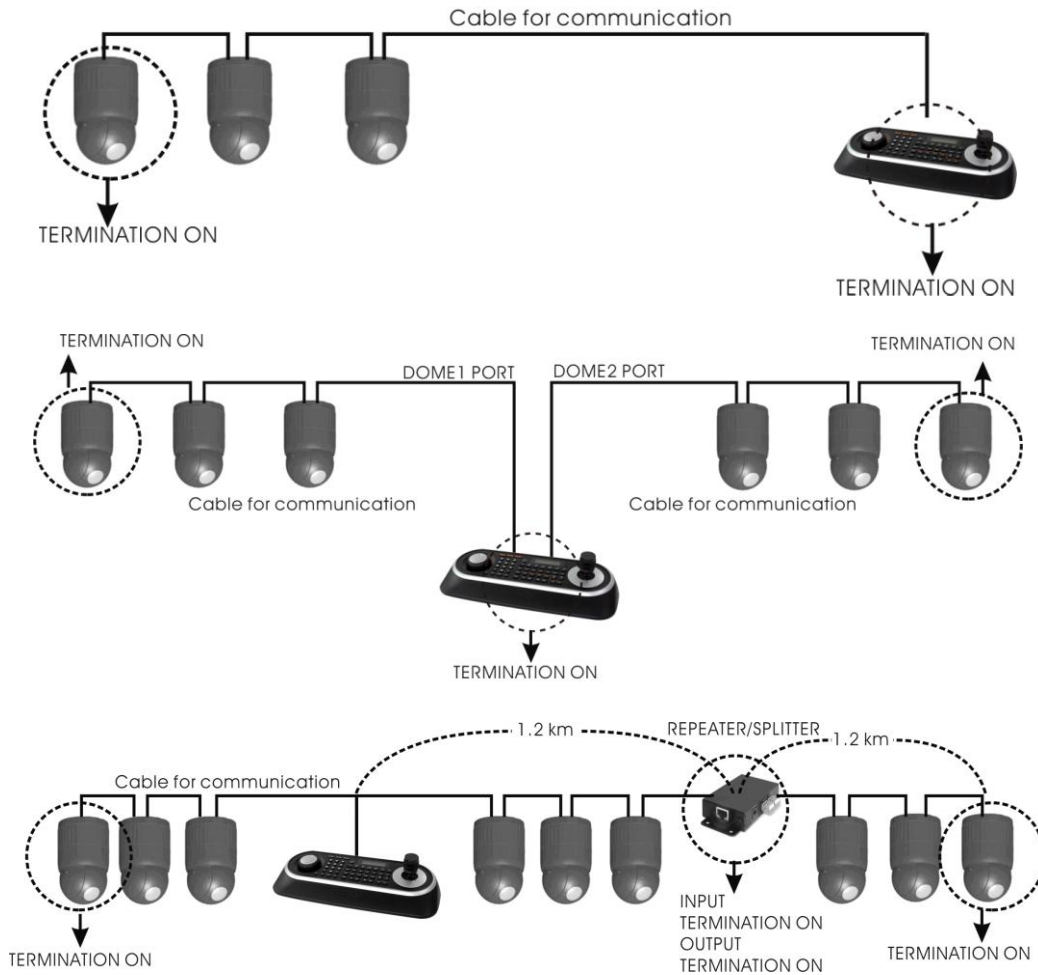

Figure 6 – Termination

2.6 Dip Switch Settings.

Termination and Master/Slave: Set the switches according to your configuration.

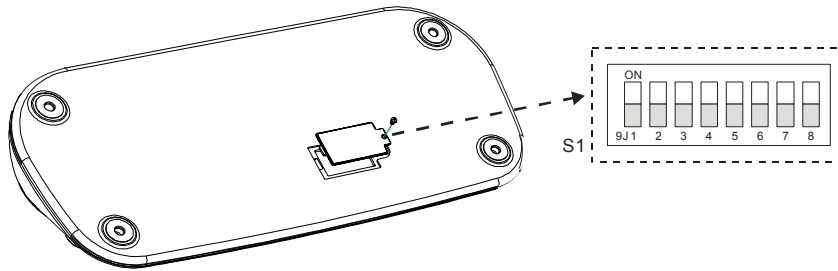

Figure 7 – Keyboard DIP Switches

NO	SETTING	DESCRIPTION
1	ON	DOME1 Termination
	OFF	
2	ON	DOME2 Termination
	OFF	
3	ON	J-BOX Data2 Termination
	OFF	
4~6	OFF	Reserved
7	ON	DOWNLOAD ON
	OFF	DOWNLOAD OFF
8	ON	SLAVE
	OFF	MASTER

Table 1 - S1 Switch Setting

2.7 Multiplexer Configuration

Duplex setup:

NOTE: Multiplexers to be controlled by the keyboard controller require a new ROM version. The new multiplexer ROM accepts control instructions from the keyboard controller. If your multiplexer's serial number is **M104xxxx** or higher, then it is ready to accept control instructions. Alternately, you can check the status of your multiplexer by pressing the Menu key of the multiplexer and then selecting item 9. If you see the "*** Protocol" option line in the Communication Setup menu, your multiplexer has the new ROM, and you do not need to replace the ROM. If your multiplexer has the old ROM version, contact your distributor on how to get new a ROM.

CAUTION: Before opening the multiplexer, make certain you are working on an antistatic work surface and that you are wearing a grounding wrist strap. Also, be very careful to orient the ROM chip correctly and not bend any of the pins.

NOTE: Replace the multiplexer firmware with the new multiplexer ROM (U45) as follows;

Remove the top cover of the multiplexer, and locate the ROM (U45). Before removing the ROM, note the orientation of the ROM. After removing the old ROM from the socket, insert the new ROM.

Be careful to orient the new ROM the same as the old ROM.
(Refer to the Multiplexer instruction manual.)

Set the multiplexer functions as follows:

(Press the Menu key of the multiplexer to enter the Unit Options menu.)

9 Unit Options

Unit Number: 001 (first Mux) or 002 (second Mux)

Communication Type: RS 485

Baud rate: 9600 bps

PORT: ON

** Protocol:** B (If you see this line, the multiplexer has the new ROM)

** The old ROM version does not show Protocol selection option.

Multiplexer alarm inputs will function normally, but the Dome controller has no way of knowing about alarms wired to the Multiplexer. If a Dome preset is required for such an alarm, you must connect the same alarm input to both the multiplexer and Dome.

Triplex setup: Unit setup
Network Type: RS 485
Baud Rate: 9600 bps
Unit address: 001 ~ 128
Protocol: B1

Chapter 3 — Keyboard Setup

To setup the keyboard controllers, the user needs to setup the network, passwords and perform special tasks such as Uploading and Downloading programmed data from the dome cameras. To enter the Keyboard menu, press and hold **CTRL** and press **MENU** expressed as **CTRL+MENU** in the manual. You will see the following menu.

```

MAIN MENU
1.Configuration
    
```

- To scroll menu items, move the joystick up or down.
- To enter the sub menu, push the joystick to the right.
- To change the value, twist the joystick handle.

```

MAIN MENU
1.Configuration
2.Network
3.camera
4.Time/Date
5.Alarm
6.LCD
7.Data Bank
8.Initialization
9.Hold time:005s
Save and Exit
    
```

3.1 Configuration

1. Key beep:ON	ON: the KBD controller’s internal speaker will sound when you press key.
2. key-lock:OFF	OFF - Disable Auto Key-Lock function. 15Min, 30Min, 60Min - After elapsed setup time, keyboard locks automatically. User needs the login password to operate the Keyboard again
3. S-Range:32	Scan Range: 32, 254, 3999 –scan dome cameras up to setting number.
4. Chg User PW	Enters the change user password submenu.
5. Chg Admin PW	Enters the change administrator password submenu.
6. Rescan dome	Rescan the connected dome cameras.
Save and exit	Save the changed settings and return to the previous menu

Change User Password

```

Current PW : XXXX
NEW PW : YYYY
Confirm PW : YYYY
Save and Exit
    
```

This screen allows you to change user password.

Enter 4 digits password and press **ENTER** . Factory Default setting is 1111.

The user is not allowed to setup or program the KBD controller and the Dome Camera.

Change Administrator Password

```
Current PW : XXXX
NEW PW : YYY
Confirm PW : YYY
Save and Exit
```

This screen allows you to change administrator password.

Enter 4 digits password and press **ENTER** . Factory Default setting is 9999.

Note) Factory default Administrator's password is 9999 + ENTER .

User password is 1111 + ENTER

If you forgot your own password, contact service personnel or distributor.

3.2 Network

1. J-BOX Set: OFF	Select to use the optional Junction Box or not.
2. Set Port	Select the baud rate and the connected unit's protocol.
3. MUX Config	Set the multiplexer configuration.
4. Set Slave KBD	Select to use the slave keyboard or not.
Save and exit	Save the changed settings and return to the previous menu

Set Port

```
1.Set Baud Rate
2.Com Ports
Exit(ESC)
```

Set Baud Rate	Enters the Baud Rate setup submenu.
Com Ports	Enters the Communications Ports setup submenu.
Exit	Return to the previous menu.

Set Baud Rate

```
Set Baud Rate
1.DOME1      : 9600
2.DOME2      : 9600
3.RS232      : 9600
Save and Exit
```

```
Set Baud Rate
1.DOME1      : 9600
2.D2/DVR     : 9600
3.ALARMPC    : 9600
4.MUX/KBD    : 9600
5.DVR/AUX    : 9600
Save and Exit
```

< J-BOX :OFF>

< J-BOX :ON>

Com Ports

```

Com Ports
1.DOME1 : DOME
2.DOME2 : NONE
3.RS232 : NONE
Save and Exit
    
```

```

Com Ports
1.DOME1 : DOME
2.D2/DVR : NONE
3.ALARMPC: NONE
4.MUX/KBD: NONE
5.DVR/AUX: NONE
Save and Exit
    
```

< J-BOX :OFF>

< J-BOX :ON>

J-BOX :OFF		
DOME1	2400~38400	None/Dome/DVR5
DOME2	2400~38400	None/Dome/DVR1-5/PC-DVR/ KBDDUP/KBDTRI/AUX IN
RS232	2400~38400	None/DVR1-5/PC-DVR/AUX IN
J-BOX :ON		
DOME1	2400~38400	RS485 :None/Dome
D2/DVR	2400~38400	RS485 :None/Dome/DVR1-5/PC DVR/AUX IN
ALARMPC	2400~38400	RS232 :None/AUX IN
MUX/KBD	2400~38400	RS485 :None/DUPLEX/TRIPLE /AUX IN
DVR/AUX	2400~38400	RS232 :None/DVR1-5/PC-DVR/AUX IN

KBDDUP : Keyboard + Duplex Multiplexer

KBDTRI : Keyboard + Triplex Multiplexer

AUX IN : outputs the auxiliary signal input to Dome1(FASTRAX,PELCO only)

Note: When the DVR is selected at a port, the other port displays the same DVR only. To change the DVR number at the other port, first change the current DVR number to none.

Note: JBOX is an optional device that is not included with the KBD.

JBOX menu has to be set to OFF in the menu if you do not have this optional JBOX.

MUX Config (Multiplexer Configuration)

This screen allows you to set multiplexer switching settings when you select the camera by pressing **NO** + **CAM**. Up to 64 Cameras can be installed using 5 MUXs and 4 keyboards. It is equivalent to a 64x4 matrix system. Each four users can view one of 64 cameras to his own SPOT(AUX) monitor.

```

MUX Config
1.MUX Channel : 16
2.Set MUX A
3.Set MUX B
Save and Exit
    
```

This menu is for assignment when multiplexers are installed in two levels. Two levels means that spot outputs of the first level multiplexers is connected to the video input of the second level multiplexer. Press **NO** + **CAM** will display the selected camera on the spot output of the second level multiplexer.

MUX Channel: NO(no use), 16, 28, 32, 48, 64 – Select the MUX channel number used in the multiplexer configuration.

When you select the desired number, the MUX configuration table is made automatically according to the number as the figure 8.

When the configuration is different from the auto-setting, you can change the value individually as below.

Set MUX A

Cam<-	MUX	In	Out
0001	001	01	01

This menu is for assignment the first level (A level) of MUX.

Cam : Dome camera ID

MUX : MUX ID

In : Input of MUX

Out : Spot Output number of the MUX

(01: master keyboard, 02: slave keyboard 1, 03: slave keyboard 2, 04: slave keyboard 3)

1. Move the cursor (←) on the **Cam** column by the joystick.
2. Twist the joystick handle to change the value.
3. Move the cursor (←) on the **MUX** column by the joystick.
4. Twist the joystick handle to change the value.
5. Move the cursor (←) on the **In** column by the joystick.
6. Twist the joystick handle to change the value.
7. Press **CTRL** or **ESC** to exit.
8. To save data, move the joystick right on 'Save and Exit' row in MUX Config.

Press **OFF** to delete the camera number.

Set MUX B

Cam<-	MUX	In	Out
0001	005	01	01

This menu is for assignment the second level (B level) of MUX.

Cam : Dome camera ID

MUX : MUX ID

In : Video Input number connected from the spot output of the first level's MUX.

Out : Spot Output number of the MUX

(01: master keyboard, 02: slave keyboard 1, 03: slave keyboard 2, 04: slave keyboard 3)

For example: When the MUX channel is 64:

At the master keyboard, pressing **64** + **CAM** is operates as below.

Cam<-	MUX	In	Out
0064	004	16	01

MUX A: the multiplexer 04 outputs camera (ID=64) of the video input 16 to the spot output 1.

Cam<-	MUX	In	Out
0064	005	13	01

MUX B: the multiplexer 05 outputs the camera (ID=64) of the video input 13 to the spot output 1.

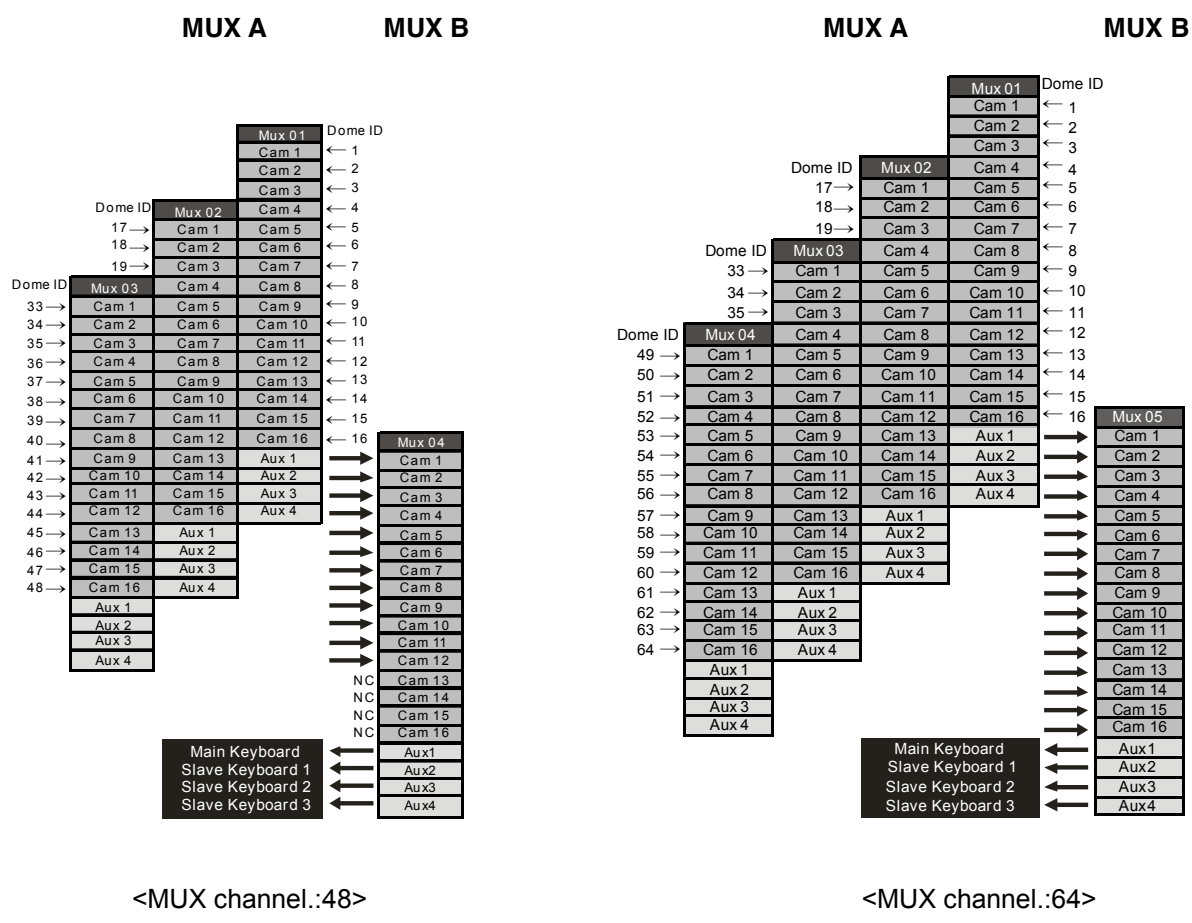
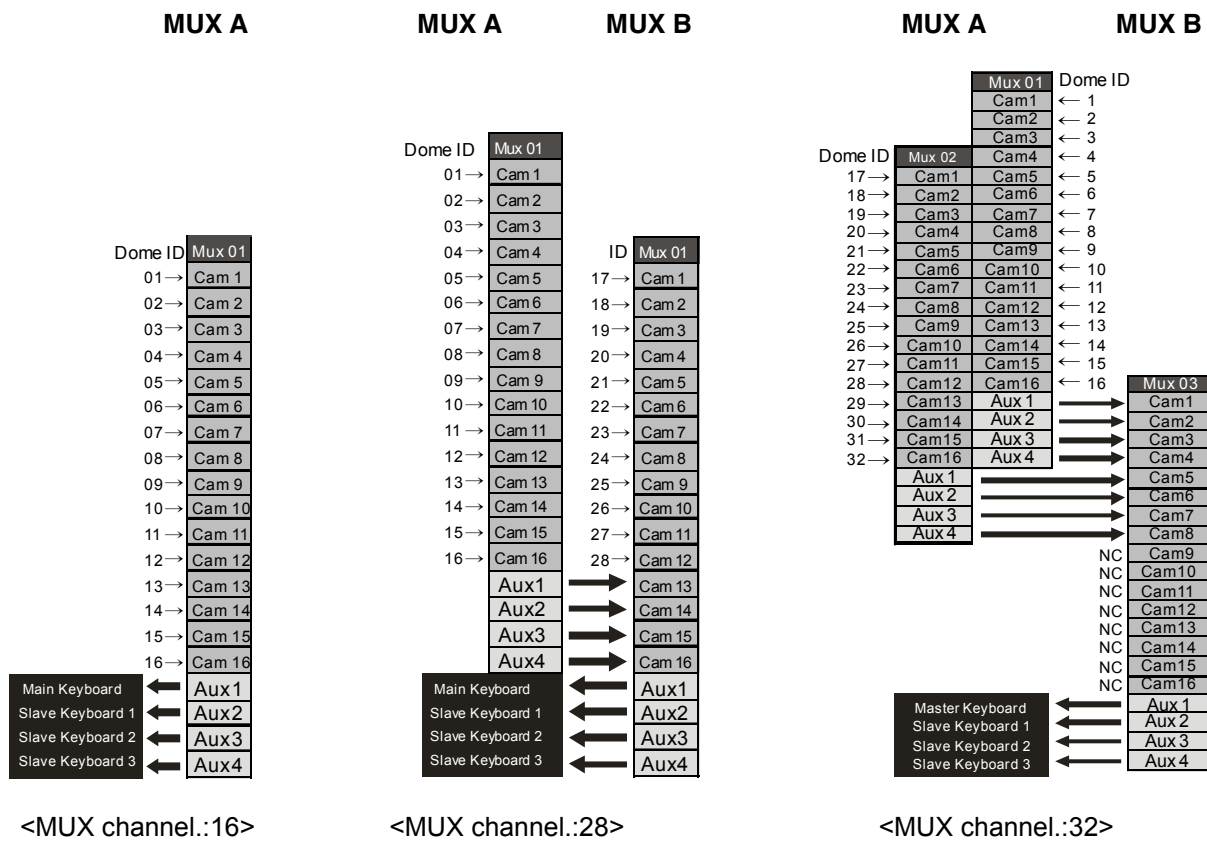

Figure 8 – MUX configuration

Set Slave Kbd



This screen allows you set up Slave KBD controller, how many the slave KBD controller and Mux menu controllability and DVR menu controllability, etc.

1. Slave KBD	ON: Slave KBD controller can control the unit which is connected Master KBD controller.
2. MUX control	ON: Slave KBD controller is allowed to access Mux setup menu.
3. DVR control	ON: Slave KBD controller is allowed to access DVR setup menu.
4. Dome Menu	ON: Slave KBD controller is allowed to access Dome menu setup.
5. Slave KBD Unit	Enters the Slave keyboard unit submenu.
Save and exit	Save the changed settings and return to the previous menu

Slave KBD Unit

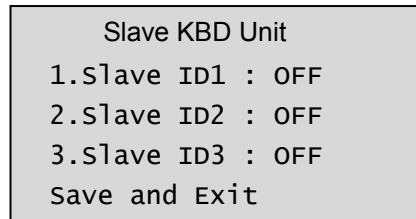

This setup allows you set up the slave keyboard, how many slave keyboards.
To use the slave keyboard, set ON.

3.3 Camera

Cam : Camera ID
 PR : Protocol[F2,F2E,P-D(PELCO-D),P-P(PELCO-P)]
 PT : Port[D1(DOME1),D2(DOME2)]
 BR : Baud rate

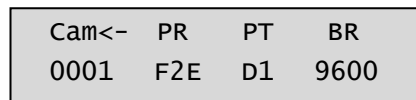

This camera setup is listed up to 64 cameras and the camera ID has up to 3999.
 When the keyboard has that the **Alarm Check** option is ON, the camera setup is set automatically after the keyboard checks the camera at the first power on or after the scan dome function.

At this time, the F2E protocol could not be changed.

To add the other camera:

1. Select the blank line (- - -) by moving the joystick down or up.
2. Twist the handle of the joystick clockwise, then the next camera number displays or press camera number and **CAM** key, if that number is not already defined, the camera number displays.
3. Set the appropriate protocol and port moving the cursor (←) by the joystick.
Alarm check option is ON: P-D (PELCO-D), P-P (PELCO-P)
Alarm check option is OFF: F2, F2E, P-D (PELCO-D), P-P (PELCO-P)
4. Set the appropriate baud rate of the camera.
5. Repeat step 1-4 to add a new camera.
6. Press **CTRL** to save and exit.
7. To change the camera, repeat step 2-6 after selecting the desired camera number.

Press **OFF** to delete the saved camera.

Press the **ESC** key to exit without saving.

Note) The baud rate of the F2E is according to the value of the set baud rate menu.

When the keyboard has that the alarm check option is OFF, the camera setup displays the blank value after the first power on. At this time, set all cameras according to the procedure above.

3.4 Time / Date

TIME/DATE	
1. Display	:ON
2. Year	:2007
3. Month	:JUL
4. Day	:02 MON
5. Hour	:12
6. Minute	:20
Save and Exit	

Set the KBD controllers' Time & Date

3.5 ALARM

Alarm	
1. Check	:ON
2. Beep	:ON
Save and Exit	

1. Alarm Check	When set to ON, the KBD controller will check alarm signal and each port can be connected 32 dome cameras. When set to OFF, it will not check alarm signal and each port can be connected 128 dome cameras.
2. Alarm Beep	When set to ON, the KBD controller will sound beep when alarm signal is detected.
Save and exit	Save the changed settings and return to the previous menu

NOTE: When domes are installed more than 64 at one dome port, you should set the alarm

check to OFF.

3.6 LCD

- Bright : 01~12
- Backlight : ON/OFF

```
LCD
1.Bright :03
2.Backlight :ON
Save and Exit
```

3.7 DATA BANK

```
Data Bank
1:Download->
2:Download->
Exit(ESC)
```

The data bank function allows you to download the programmed data from the selected camera and to upload the saved data of the keyboard to the selected camera.

Push the joystick to the right to download.

```
Data Bank 1
065.5%
```

After downloading, if success, press **ENTER**.

```
Data Bank 1
Download OK
```

After downloading, if fail, press **ENTER**.

```
Data Bank 1
Download Error
```

After downloading, it displays as the right figure.

```
Data Bank
1: 0001E
2: Download->
```

To upload, select the upload and push the joystick to the right.

```
Data Bank 1
Upload
Clear Data
Exit(ESC)
```

To clear the saved data, select the clear data and push the joystick to the right.

3.8 INITIALIZATION

To initialize the keyboard, select Initialization.
After Initialization, the keyboard returns it to the factory value.

MAIN MENU
8.Initialization

ARE YOU SURE?
ENTER OR ESC

3.9 HOLD TIME

MAIN MENU
9.Hold time:005s

When the dome ID of the master keyboard is the same as the slave keyboard or the one from AUX IN mode(dome2 port), during the hold time after the master keyboard control the dome, the slave keyboard and the unit from the AUX IN mode(dome2 port) cannot control the dome.

INF (Infinite)	Slave Keyboard user never has the right to control the dome which is selected by master Keyboard users.
1 ~ 200 second	After select hold time, the slave keyboard can control the dome.

When the dome ID of the master keyboard is not the same as the slave keyboard or the one from AUX IN mode (dome2 port), the hold time has no relation.

Chapter 4 — Slave Keyboard Setup

Master keyboard should be setup as following procedure.

1. Check for dip switch **the 8th of S1** “OFF”.
2. Press **CTRL + MENU**. Check Slave KBD setting “ON”.
 Network ▶ Set Slave KBD ▶ Slave KBD : ON
 Network ▶ Set Slave KBD ▶ Slave KBD Unit: ON for the desired slave keyboard

Slave keyboard need to be setup with the following procedure.

1. Check for dip switch **the 8th of S1** is “ON”.
2. If you setup all connection correctly and turn on slave keyboard, you should see following screen.

```
Ver x.x Slave1
Password : xxxx
```

←Current Device ID = 1
 ←Default setting is **9999** for administrator, **1111** for user

```
Not connected
```

←means that the controller is not connected to master keyboard

3. Press **CTRL + MENU**. Set the Slave ID to 01

```
MAIN MENU
1.Configuration
2.Network
3.LCD
4.Initialization
Exit(ESC)
```

```
Configuration
1.Key Beep : ON
2.key Lock : OFF
3.Chg User PW
4.Chg Admin PW
Save and Exit
```

```
Network
1.J-BOX Set : OFF
2.Keyboard ID : 01
3.BPS:9600
Save and Exit
```

```
LCD
1.Bright :03
2.Backlight :ON
Save and Exit
```

Chapter 5 — Install with DVR Series

5.1 Install with Standalone DVR Series

When user wants to connect with DVR, proceed as the following order.

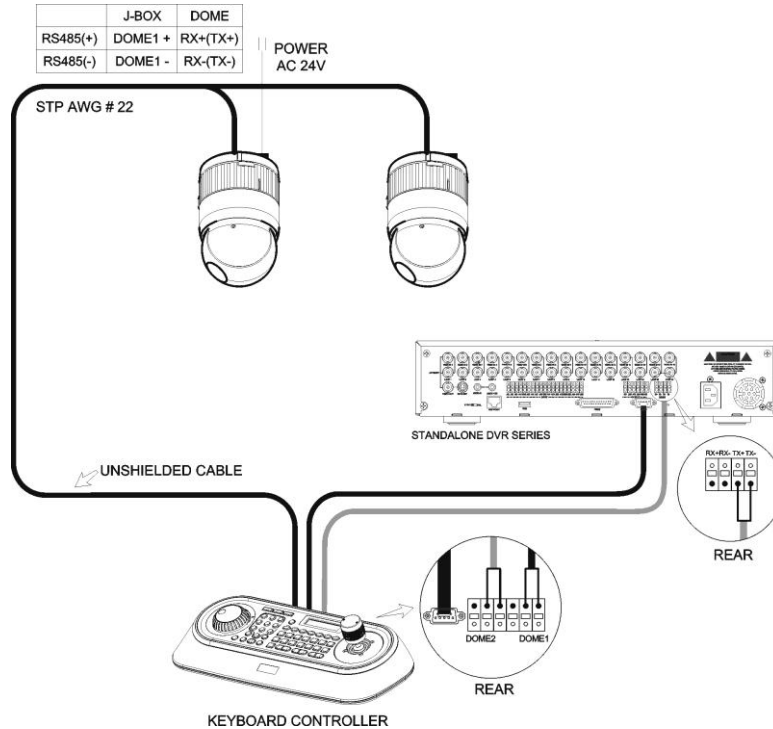

1. Connect RS232 cable between RS-232 Port of DVR and RS232 of the Keyboard. (This connection enables DVR control remotely from KBD controller)
2. How to setup the KBD controller.
 - A. Turn the Keyboard ON
 - B. Input password (Factory setting is 9999)
 - C. Open the menu of the KBD controller by pressing **CTRL + MENU** Key.
 - D. Set as below in Network menu.

Set Baud Rate		Com Ports	
DOME1	: 9600	DOME1	: Dome
DOME2	: 9600	DOME2	: AUX IN
RS232	: 9600	RS232	: DVR1-DVR4

3. How to setup DVR

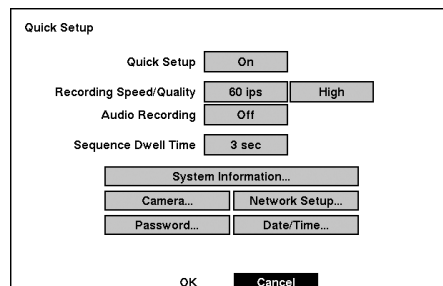

- A. Press "OK", and the below screen will be appeared.

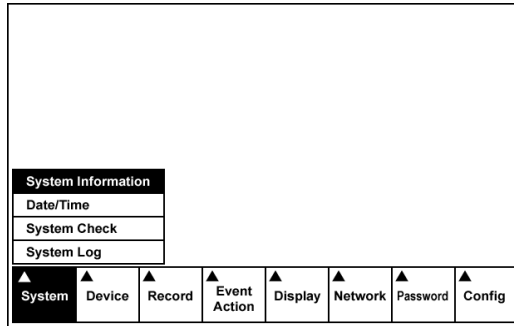

B. Select "System Information" on the system menu and change UNIT ID.

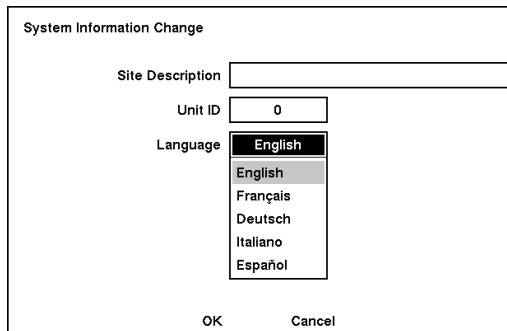

C. Select "Camera" on the Device menu. Unit ID should be 1 up to 99. Unit ID is not allowed number "0".

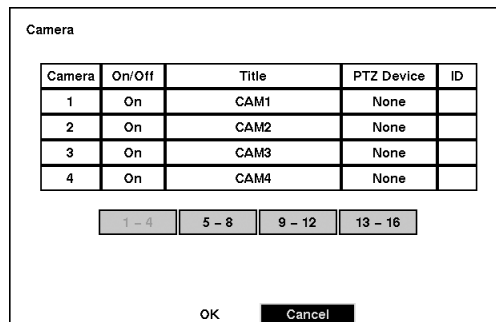

D. Set "PTZ Device" and "ID" of the dome camera. Select RS232/RS485 after PTZ is installed, and then set-up as below table.

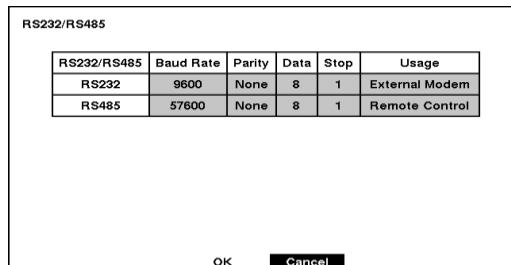

RS232/RS485	Baud Rate	Parity	Data	Stop	Usage
RS232	9600	None	8	1	Remote Control
RS485	9600	None	8	1	PTZ Control

4. After setting Unit ID, Camera, and RS232/RS485, installing dome camera is basically completed. Please refer to the manual of DVR for the other installation.
5. Press the related number of the controller which is correspondent to unit ID of DVR. Then press DVR button and adjust unit ID of the controller
6. Make sure if any change is appeared on screen when you press  button of the controller for basic testing. If there's no change appeared, verify cable connection and setting of installation.

5.2 Install with PC DVR Series

If user wants to connect with PC DVR, please proceed as the following order.

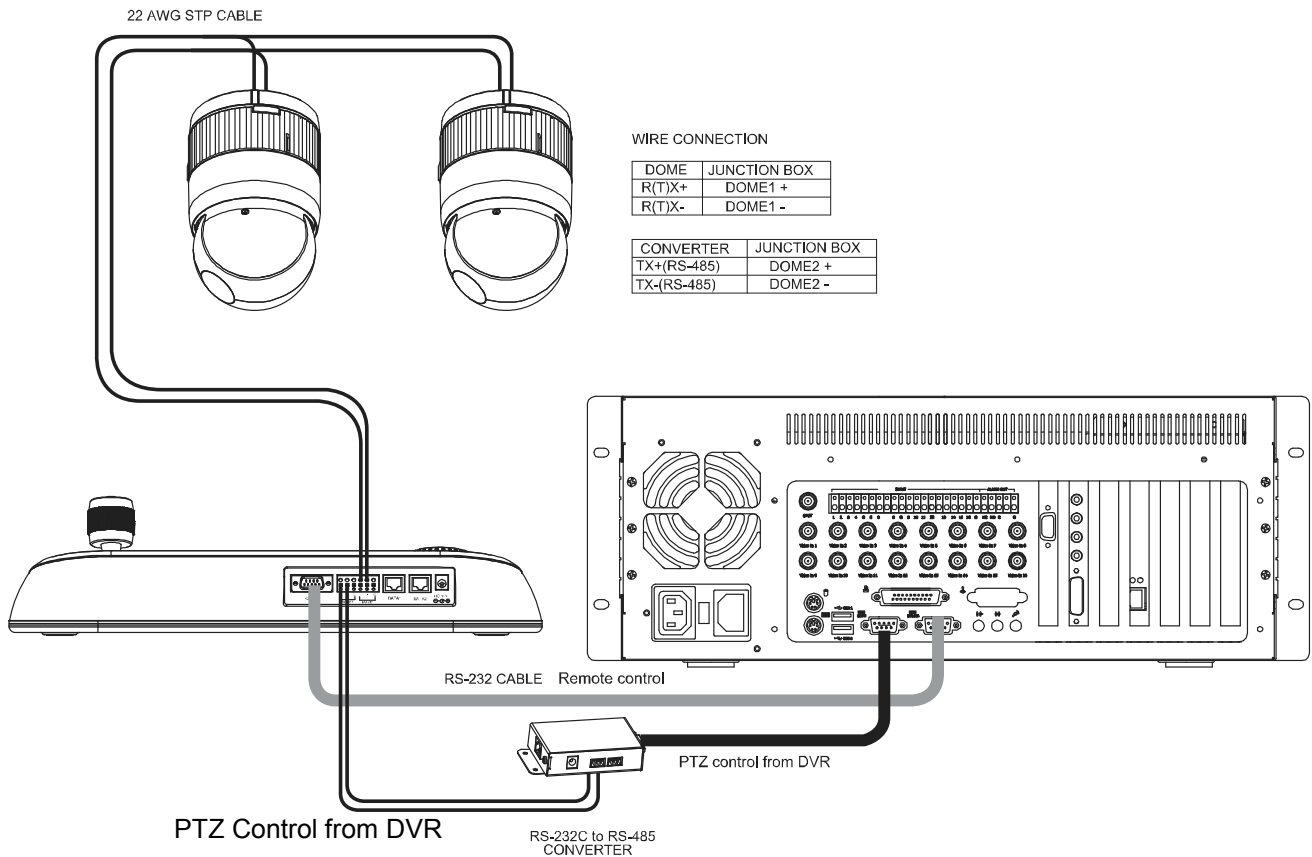

Figure 11 – PC DVR Connection Diagram

1. Connect RS-232C cable between RS-232C Port of PC DVR and RS-232C port of the Keyboard. (This connection enables PC DVR control remotely from KBD controller)
2. Plug the RS-232C TO RS-485 converter in the RS-232C Port of PC DVR. Connect wires between the TX(+/-) of converter and DOME2(+/-) of Keyboard. (This connection enables PC DVR PTZ control from KBD controller)
3. How to setup the KBD controller.
 - A. Switch the KBD controller ON
 - B. Input password (Factory Setting is **9999**)
 - C. Open the menu of the KBD controller by pressing **CTRL + MENU** Key.
 - D. Set as below in Network menu.

Set Baud Rate		
DOME1	:	9600
DOME2	:	9600
RS232	:	9600

Com Ports		
DOME1	:	Dome
DOME2	:	AUX IN
RS-232	:	PC-DVR

4. How to setup PC DVR

- A. Switch the PC DVR on.



- B. If press setup button on the above screen, the below screen will be appeared.

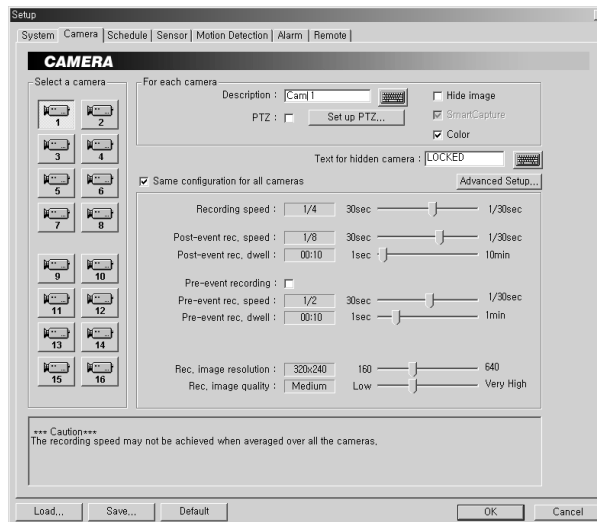

- C. Select camera input number that dome camera connected. Then install as below to select set-up PTZ after checking PTZ box.

```
Port       : COM1
RX Device  : Fastrax...
Baud Rate  : 9600
Data       : 8
Parity     : None
Stop Bit   : 1
```

- D. If PTZ is not necessary for PC DVR, cable and installation here is not needed. (PC DVR is able to be controlled remotely and there's no PTZ function)

5. How to PC DVR Remote setup

- A. If selects Setup on main menu, the below screen will be appeared.

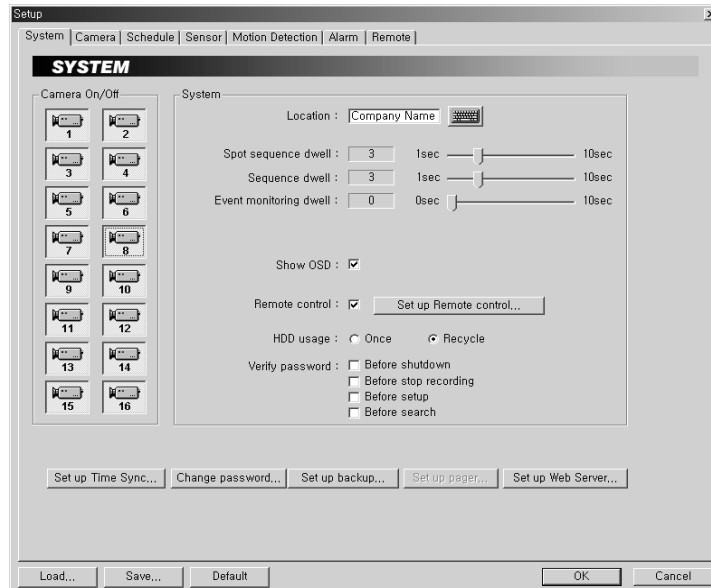

- B. After selecting System and checking Remote control box, please install as below to select Setup remote control. Device ID is not allowed number "0".

```
Port      : COM2
Baud Rate : 9600
Data      : 8
Parity    : None
Stop Bit  : 1
Device ID : XX
```

- C. Make sure if any change is appeared on screen to press **QUAD** (Next Screen) button of a controller for basic testing. If there's no change appeared, check cable connection and installation again.

Chapter 6 — Operation

6.1 Keyboard Lock/Unlock (Hidden command)

When the user leaves the control desk, he may wish to lock the keyboard controller to prevent unauthorized use.

Pressing **7 7 7** + **ENTER** will lock the keyboard controller. Pressing **7 7 7** + **ENTER** while the keyboard is locked will open the password screen. If the correct password is entered, the keyboard controller will return to normal operation.

If the power is turned OFF and ON while the keyboard is locked, it will ask for the password. Entering the correct password will cause the keyboard controller to return to normal operation.

NOTE : If you forget your own passwords, turn off the keyboard controller, contact your distributor to get a 4-digit back door password. This will change the passwords to the factory default. Contact your distributor to get the 4-digit back door password.

6.2 Controlling Multiplexer

Using a multiplexer allows more flexibility in the types of cameras that can be used in a full system. Dome cameras and regular cameras can be mixed.

The keys **PIP**, **2x2**, **3x3**, **4x4**, **ZOOM**, **SET**, etc., are keys that are used to operate the multiplexer.

6.2.1 Selecting Multiplexer

Duplexer : Press **MACRO/MENU** key to enter Multiplexer set up menu and hold down the **ENTER** Key while navigating using the joystick. (**ENTER+Joystick**)

Triplexer : Push the **Joystick** upward with the **ENTER** pressed (**ENTER+Joystick**) will show the Mux menu.

It will act like a mouse. Rotating the handle clockwise will act like the set key of the multiplexer. Rotating counterclockwise will act like the **ESC** key of the Multiplexer.

Selecting multiplexer (Mux ID **No.** + **MUX**)

Example: If the unit address of the Multiplexer is 128, you should press **1 2 8** + **MUX** to control the 128th Multiplexer.

6.2.2 Dome Camera Selection

Selecting camera (**No.** + **CAM**)

With these selections, the keyboard controller has full control of the selected camera if it is a dome camera.

Viewing full screen mode (Mux ID **No.** + **MUX**, Multiplexer video input **No.** + **MAIN**)

Select cameras 1 to 16 by pressing the camera number and then Main. The selected camera will appear in the full screen mode and is under control if it is a dome camera.

Picture on Spot output monitor (**SPOT No.** + **SPOT** + Camera **No.** + **ENTER**)

Pressing SPOT **No.** + **SPOT** + Camera **No.** + **ENTER** will switch the selected camera number to the specific spot monitor output of the multiplexer. The selected camera can be a dome camera or a standard camera. The Keyboard controller maintains control of the previously selected dome camera. It does not change the main output of the multiplexer.

Example:

1 + **MUX**, **2** + **SPOT** + **12** + **ENTER** will switch camera 12 on multiplexer 1 to the spot output 2 of multiplexer 1.

2 + **MUX**, **1** + **SPOT** + **16** + **ENTER** will switch camera 16 on multiplexer 2 to the spot output 1 of multiplexer 2.

6.3 Summary of Keyboard Controls

Key operation example

CTRL + MENU : Press and hold down **CTRL** Key and press **MENU** Key.







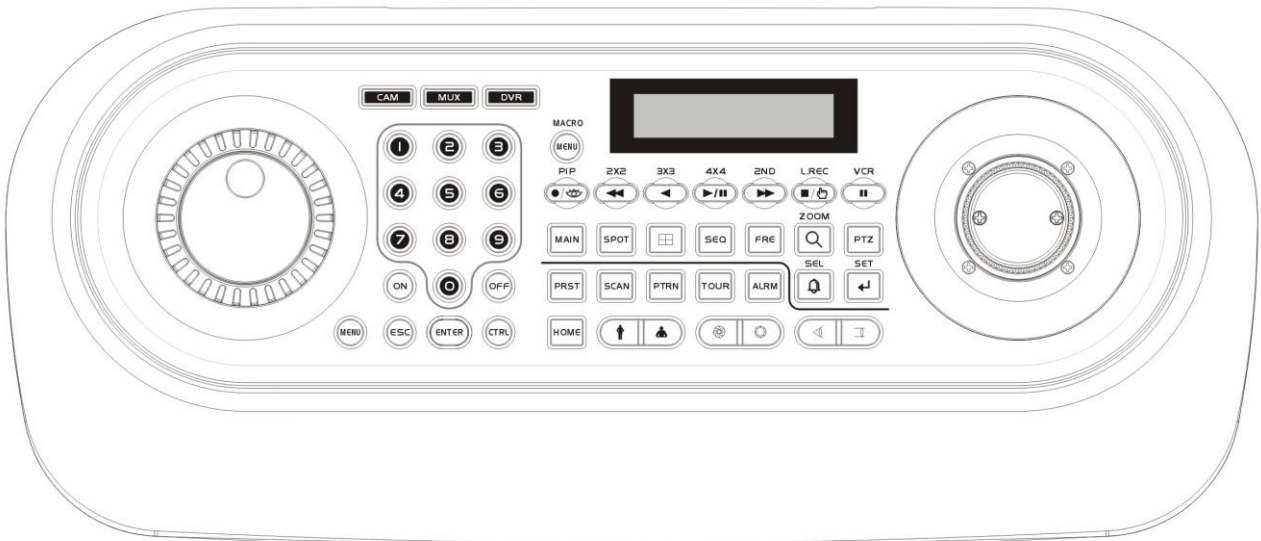









1 + CAM : Press **1** Key, **CAM** Key sequentially.

CTRL + JOYSTICK : Press and hold down **CTRL** Key while manipulate **Joystick** Handle.

ENTER + JOYSTICK : Press and hold down **ENTER** Key while manipulate **Joystick** Handle.

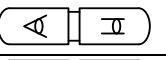

6.3.1 Keys for Dome camera

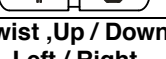









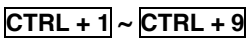

Function	Key Label	Descriptions
Camera Selection		Displays the selected camera on the spot out of the multiplexer and allows the camera to be controlled by the keyboard controller, if the selected camera is a dome camera. Function number selection with function keys. (e.g., 1 + CAM , 3 + TOUR , 5 + SCAN , 6 + PRST)
Cancel		Cancels current inputs. Exits from currently running functions or menu, error status, etc.
Alarm		Disregards all currently activated alarms and turns off the beep temporarily. If alarm is activated again within the programmed hold time, the timer will restart and beep again.
Relay ON		Relay No. 1 ~ 4 + ON will activate the selected relay.
Relay OFF		Relay No. 1 ~ 4 + OFF will disable the selected relay.
Home		Immediately calls Home function. Deletes selected value or function in programming mode
Global		Sends all cameras to preset (e.g., 1 , 2 ... 55 + ENTER). 888 + ENTER : Night shot mode, 999 + ENTER : Normal mode
Call Preset position		Pressing Prst will bring up the preset programming menu. Recalls preset; (e.g.; 1 , 2 ... 31 ... 240 + PRST) In the preset or tour programming mode, the operator can review the exiting preset (selected by cursor) by pressing this key.
Tour		Pressing TOUR will bring up the tour programming menu directly Recalls programmed presets or functions sequentially. (e.g., 1 + TOUR)
Pattern		Pressing PTRN will bring up the pattern programming menu directly. Repeats the selected pattern of the current dome camera. (e.g., 1 + PTRN)
Auto Scan		Pressing Scan will bring up the Auto Scan programming menu. Calls Auto panning function (e.g., 2 + SCAN repeats Auto Scan 2).
Configuration		Enters programming menu. CTRL+MENU will invoke Keyboard set up menu
Program		No. + CTRL + PRST will store current view as a preset directly. No. + CTRL + TOUR will open programming menu No. + CTRL + SCAN will open programming menu
Control		CTRL+Joystick : In a programming mode (Preset, Pattern, Scan, Privacy....) the joystick operates as if in the normal control mode. While pressing and holding down the CTRL key, all movements of the joystick will start recording when in the pattern programming menu. CTRL+Joystick :. In normal operation mode, manual speed of the joystick control will be operated in turbo mode.
Enter		Completes entering data for the password or title ENTER+Joystick : Direction key in DVR remote mode or Mux (PTZ, Mouse, Cursor)
Manual Focus		Overrides auto focus. Moving the Zoom handle reactivates Auto Focus mode.
Manual Iris		Overrides auto iris. Moving the joystick reactivates Auto Iris mode.
Zoom		Zoom control.
Joystick	Twist ,Up / Down Left / Right	Zoom control (proportional to position) Tilt control, Cursor Up / Down in the menu Pan control, Cursor Left / Right or Page scroll in the Menu.

6.3.2 Keys for Multiplexer

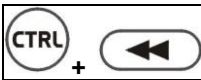
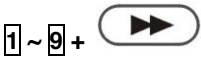
Function	Key Label	Descriptions
Select Mux ID		Select Multiplexer (e.g.; 1 or 2 + MUX)
Full Screen		Puts the multiplexer in Full-Screen Mode of the selected camera No.
PiP		Picture-in-Picture mode.
2 by 2 Display		Displays view of four cameras. The remaining cameras can be sequenced in the lower-right window.
3 by 3 Display		Displays view of nine cameras. The remaining cameras can be sequenced in the lower-right window.
4 by 4 Display		Displays view of 16 cameras in 1/16-size pictures.
2nd		Second mode of PIP multiplexer. Pressing 2nd + ENTER again will return to normal mode.
Panic record		Put a camera in the Panic Record Mode.
Macro		Same as Menu key in the Duplexer model. Same as Macro key in the Triplexer model.
Select or Alarm		Same as Select key in the Duplexer model. Same as Alarm key in the Triplexer model.
Freeze		Freeze the video from the currently selected camera.
Digital Zoom		Enter the Zoom Mode.
Sequence		Put the multiplexer in the Sequence Mode.
VCR		Switch the multiplexer into VCR playback mode.
SET		This button has several functions. It brings up a Popup menu, sets selections on the OSD menus and decreases numbers in the number setup function.
Spot output		Displays selected camera as spot output of the current Multiplexer. (e.g., 2 + SPOT + 1 + ENTER will display camera 1 as a spot output 2of the current Multiplexer)
Cursor movement		Up / Down / Left / Right control in the ZOOM and SET UP mode. Handle turn clockwise for SET mode. Handle turn counterclockwise for ESC mode.

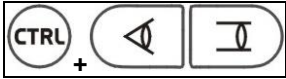























6.3.3.1 Keys for DVR [DVR1-4, PC-DVR]

Function	Key Label	Descriptions
Id Selection		DVR ID Selection. (e.g.:1 or 2 + DVR).
MENU		Enter the Quick Setup screen. You will need to enter the administrator password to access the Quick Setup. Pressing the button also closes the current menu or setup dialog box.
Record		[DVR1,DVR3] Record on and off. [DVR2,DVR4] Turn the panic record on and off.
Recall Preset		Recall the preset number in the PTZ mode.
Rewind		Play video backward at high speed. Pressing the button again toggles the playback speed from , and .
Reverse Play		No operation
Play/Pause		[DVR1- 4] Play recorded data / Pause playing. [PC-DVR] Play
Fast Forward		Play video forward at high speed. Pressing the button again toggles the playback speed from , and .
STOP		[DVR1,DVR2] During Playback mode returns the DVR to the Live Monitoring mode.
SPOT		[DVR3,DVR4] Display the SPOT pop-up menu.
Save Preset		Save the preset number in the PTZ mode.
Pause		[DVR1- 4] No operation, [PC-DVR] Pause
Full Screen		Displays selected camera in the full-Screen Mode and enter the numbers in the login menu.
Spot Sequence		Toggle on and off sequence mode of the selected spot output.
Spot output		Displays selected camera as spot output of the current DVR .
Display Mode		Toggle between different display formats. The available formats are: full, 4x4, 3x3, 2x2 and PIP.
Sequence		When in the live mode, pressing the SEQUENCE button displays another full live channel sequentially. When in one of the multi-view formats, pressing this button will cause the DVR to sequence cameras in two sequence modes: "Page" and "Cameo". In the Page mode, the DVR sequences through user-defined screen layouts (pages). In the Cameo mode, the bottom, right screen to display live cameras sequentially. Pressing the SEQUENCE button while in the Sequence mode will exit the Sequence mode.
Freeze		Freeze the current live screen.
Search		Go to the playback mode and exit the playback mode.
Digital Zoom		[DVR1- 4] Enter the digital zoom mode when DVR has the digital zoom function.

Function	Key Label	Descriptions
Alarm		First, it will reset the DVR's outputs including the internal buzzer during an alarm. Second, it will display the event log when you are in the live monitoring mode unless there is an active alarm.
Enter		[DVR1- 4] Select a highlighted item or completes an entry that you have made.
Cursor movement		Up / Down / Left / Right control in the digital zoom and SET UP mode. Handle turn clockwise for SET mode. Handle turn counterclockwise for ESC mode.
Shuttle		The Shuttle Ring operates in the Playback mode only. Turning the ring clockwise plays video forward. Turning the ring counterclockwise plays video backward.
Jog		The Jog Dial operates only when playback video has been paused. By turning the jog dial clockwise, you can play video forward image-by-image.
Cam Selection		[PC-DVR] Select the camera and change the camera in the full-screen mode.
Display Mode		[PC-DVR] Change screen mode.
Go last		[PC-DVR] Go last.
Go last		[PC-DVR] Go last.
X times Forward play		[PC-DVR] Fast play at x(No.) times speed.
X times Backward play		[PC-DVR] Fast rewind at x(No.) times speed.
PTZ		[DVR1- 4] Open a Pan/Tilt/Zoom screen which allows you to control properly configured PTZ cameras.
Manual Focus		When a PTZ camera is connected to the DVR, it can control the focus. Moving the Zoom handle reactivates Auto Focus mode.
Manual Iris		When a PTZ camera is connected to the DVR, it can control the IRIS. Moving the joystick reactivates Auto Iris mode.
Zoom		When a PTZ camera is connected to the DVR, it can control the zoom position.
movement		Up / Down / Left / Right control in the PTZ mode. Handle turn clockwise or counterclockwise for then zoom control.

- * When DVR has the record button, select DVR1
- * When DVR has the panic record button, select DVR2
- * When DVR has the record button and the spot button, select DVR3
- * When DVR has the panic record button and the spot button, select DVR4
- * When DVR is the PC based DVR, select PC-DVR
- * The key for the dome control operates only when the dome is connected to the DVR by RS485 and the DVR is in the PTZ mode.

6.3.3.2 Example of Key operation in PC-DVR

Function	Key Label	Live(Guard) Mode	Playback Mode
MENU	MACRO 	NO ACTION	
Record		Record ON / OFF	
Recall Preset	No. + 	Recall Preset	
Search		Go to Playback mode	Stop
Rewind		NO ACTION	Rewind one image
X times Backward play	1 ~ 9 + 	NO ACTION	Fast rewind at x(No.) times speed.
Reverse Play		NO ACTION	Reverse Play
Play/Pause		NO ACTION	Play
Fast Forward		NO ACTION	Forward one image
X times Forward play	1 ~ 9 + 	NO ACTION	Fast play at x(No.) times speed.
STOP		NO ACTION	Go to Guard mode
Save Preset	No. + 	Save Preset	
Pause		NO ACTION	Pause in playing
Full Screen	No. + 	NO ACTION	
Spot Sequence	Spot No. +  + 	Operate according to the model or not	
Spot output	Spot No. +  + camera No. + 	Operate according to the model or not	
Display Mode		Change Display Mode	NO ACTION
Sequence		Sequence	NO ACTION
Freeze, PTZ, Enter	  	NO ACTION	
Camera Selection	No. + 	Camera Selection	

* For example, press



to enter the playback mode.

6.4 DVR5 protocol for the DVR for the version 3.1.0 and over

Installation of the DVR5 protocol when one DVR is used.

Note: When you set the protocol to DVR5, the keyboard operates as the DVR's keyboard only and you must install domes to the DVR only.

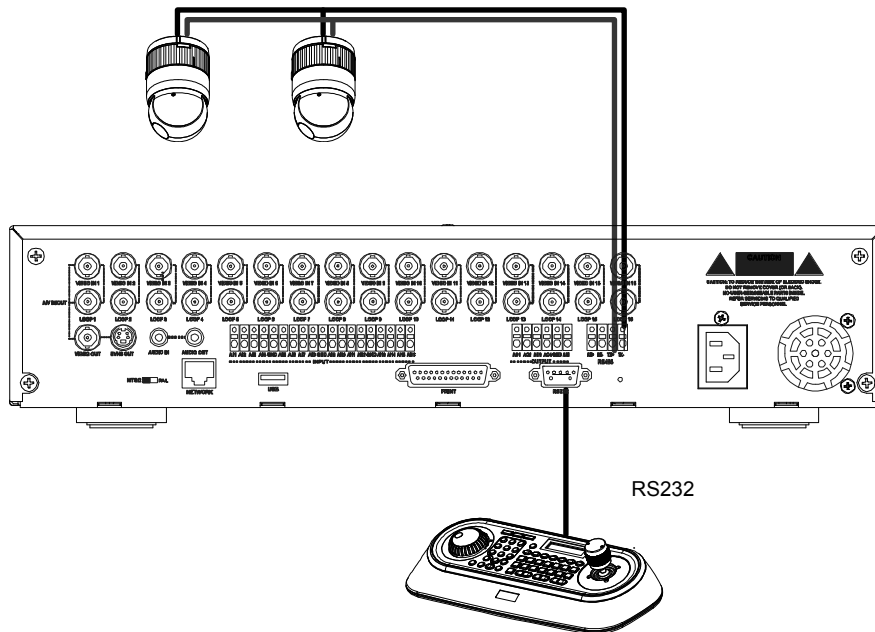

When you control the PTZ camera by the DVR, follow as below.

1. Connect RS232 cable between RS-232 Port of DVR and DVR port of the J-box. (This connection enables DVR control remotely from KBD controller)
2. Connect RS485 cables between the DVR and PTZ cameras.
3. Connect the power jack to the power port of the keyboard.
 - A. Input password (Factory setting is 9999)
 - B. Open the menu of the KBD controller by pressing **CTRL + MENU** Key.
 - C. Set as below in Network menu.

Set Baud Rate	
DOME1	: 9600
DOME2	: 9600
RS232	: 9600

Com Ports	
DOME1	: NONE
DOME2	: NONE
RS232	: DVR5

Note: The baud rate of DVR/AUX should be the same as one of the RS232 of the DVR

4. How to setup DVR:

- D. Switch the DVR on.
- E. Enter the Menu according to the DVR's instruction manual.
- F. Change the Port to "RS232" of the remote control in the devices menu.
- G. Confirm matching the setup of RS232 with the keyboard.
Ex: Baud Rate:9600,Data Bit:8,Stop Bit:1, Parity:None)
- H. Change the Remote Control to "Remote Control2" in the devices menu.
- I. Change the Port to "RS485" in the PTZ menu of the camera of the devices menu.
- J. Confirm matching the setup of RS485 of the PTZ menu with PTZ cameras.
- K. Set the PTZ menu according to PTZ cameras.

Note: The baud rate of all PTZ cameras should be used one speed type (ex. All 9600 or all 2400)

Note: The product of FASTRAX should be used "FASTRAX2"

- L. Set the ID number according to PTZ cameras.
- M. Set the system ID number to 1.

Operation of the keyboard

When the PTZ camera is installed on the DVR, you should select the number of the input channel not the ID number of the PTZ camera.

For example, when the PTZ camera with the 5 ID number is installed the number 1 of the input jack of the DVR, to control the camera, you select **1** + **CAM** not **5** + **CAM**.

Action	Key pressing	Remark / LCD display
DVR selection	1 + DVR	Displays DVR-001 at the top line
Camera selection	1 + CAM	CAM:0001 at the top line DVR-001 at the top line
	17 + CAM	CAM:0017 at the top line DVR-001 at the top line
Camera selection of DVR #2	2 + DVR	CAM:0017 at the top line DVR-002 at the top line
Camera 1 selection of DVR #2	1 + CAM	CAM:0001 at the top line DVR-002 at the top line
Return to DVR #1	1 + DVR	CAM:0001 at the top line DVR-001 at the top line
Full-screen selection	1 + MAIN	CAM:0001 at the top line DVR-001 at the top line
	16 + MAIN	CAM:0016 at the top line DVR-001 at the top line
	32 + main	CAM:0032 at the top line DVR-001 at the top line
Return to DVR #2	2 + DVR	CAM:0032 at the top line DVR-002 at the top line
Control SPOT output	1 + SPOT + 1 + ENTER	Camera 1 goes to SPOT 1 output
	2 + SPOT + 16 + ENTER	Camera 16 goes to SPOT2 output
	1 + SPOT + ENTER	Sequence SPOT 1 output
	1 + SPOT + ENTER	Stop the sequence of SPOT 1 output

Installation of DVR5 protocol when many DVR use.

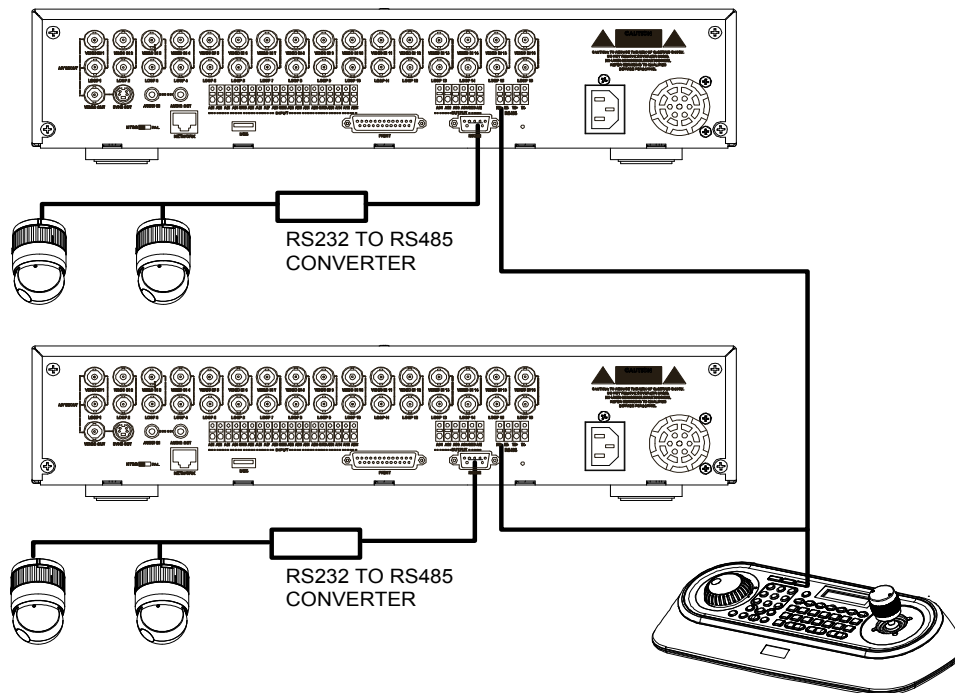

When you control PTZ cameras on many DVRs, you need RS232 to RS485 converter. PTZ cameras are connected to RS232 to RS485 converter by the RS232 port of the DVR and the keyboard is connected through the RS485 port of the DVR.

Follow as below.

1. Connect RS485 cable between RS485 Port of DVR and the DOME1 port of the keyboard.
2. Connect RS232 cable between RS-232 Port of DVR and the RS232 Port of the RS232 to RS485 converter.
3. Connect PTZ cameras to the RS485 Port of the RS232 to RS485 converter.
4. Repeat the step 1-3 each DVR.
5. Set the system ID number of each DVR from 1 to the last DVR increasing 1.
6. Set the network menu of the keyboard as below.

Set Baud Rate		
DOME1	:	9600
DOME2	:	9600
RS232	:	9600

Com Ports		
DOME1	:	DVR5
DOME2	:	NONE
RS232	:	NONE



Note: The baud rate of DOME1 should be the same as one of the RS485 of the DVR.

7. How to setup DVR:

- A. Switch the DVR on.
- B. Enter the Menu according to the DVR's instruction manual.
- C. Change the Port to "RS485" of the remote control in the devices menu.
- D. Confirm matching the setup of RS485 with the keyboard.
Ex: Baud Rate:9600,Data Bit:8,Stop Bit:1, Parity:None)
- E. Change the Remote Control to "Remote Control2" in the devices menu.
- F. Change the Port to "RS232" in the PTZ menu of the camera of the devices menu.
- G. Confirm matching the setup of RS232 of the PTZ menu with PTZ cameras.
- H. Set the PTZ menu according to PTZ cameras.(PRODUCT and ID)

Note: The baud rate of all PTZ cameras should be used one speed type(ex. All 9600 or all 2400)























Keys for Dome camera:

	Key Label	Descriptions
Camera selection	1..16 + CAM	Displays the selected camera number.
Cancel	ESC	Cancels current inputs. Exits from currently running functions or menu, error status, etc.
Alarm	ALRM	No Action
Home	HOME	Immediately calls Home function. Deletes selected value or function in programming mode
Call Preset position	PRST	Pressing Prst will bring up the preset programming menu. Recalls preset;(e.g.; 1 , 2 ... 3 1 ... 2 4 0 + PRST) In the preset or tour programming mode, the operator can review the exiting preset (selected by cursor) by pressing this key.
Tour	TOUR	Pressing TOUR will bring up the tour programming menu directly Recalls programmed presets or functions sequentially. (e.g., 1 + TOUR)
Pattern	PTRN	Pressing PTRN will bring up the pattern programming menu directly. Repeats the selected pattern of the current dome camera. (e.g., 1 + PTRN)
Auto Scan	SCAN	Pressing Scan will bring up the Auto Scan programming menu. Calls Auto panning function (e.g., 2 + SCAN repeats Auto Scan 2).
Configuration	MENU	Enters programming menu. CTRL+MENU will invoke Keyboard set up menu
Program	CTRL	No. + CTRL + PRST will store current view as a preset directly. No. + CTRL + TOUR will open programming menu No. + CTRL + SCAN will open programming menu
Control	CTRL	CTRL+Joystick : In a programming mode (Preset, Pattern, Scan, Privacy....) the joystick operates as if in the normal control mode. While pressing and holding down the CTRL key, all movements of the joystick will start recording when in the pattern programming menu. CTRL+Joystick : In normal operation mode, manual speed of the joystick control will be operated in turbo mode.
Enter	ENTR	Completes entering data for the password or title ENTR+Joystick : Direction key in DVR remote mode.
Manual Focus		Overrides auto focus. Moving the Zoom handle reactivates Auto Focus mode.
Manual Iris		Overrides auto iris. Moving the joystick reactivates Auto Iris mode.
Zoom		Zoom control.
Joystick	Twist Up / Down Left / Right	Zoom control (proportional to position). Tilt control, Cursor Up / Down in the menu Pan control, Cursor Left / Right or Page scroll in the menu.

Note: According to camera type, these functions could be different from the description.

Keys for DVR[DVR5]

*See the DVR's manual to know in detail.

	Key Label	Descriptions
DVR Selection		DVR ID Selection. (e.g.: 1 or 2 + DVR).
PTZ		Open a Pan/Tilt/Zoom screen which allows you to control properly configured cameras.
Play/Pause		Play recorded data / Pause playing.
Rewind		Play video backward at high speed. Pressing the button again toggles the playback speed from  ,  and  .
Fast Forward		Play video forward at high speed. Pressing the button again toggles the playback speed from  ,  and  .
Stop		During Playback mode returns the DVR to the Live Monitoring mode.
Record		Set the DVR so that it is ready to record video.
MENU	 MACRO	Enter the menu screen. You will need to enter the administrator password to access the menu if enabled. Press the menu button to see the search menu in the playback mode. Pressing the button also closes the current menu or setup dialog box.
Alarm		Invokes the event log search menu.
Freeze		Freeze the current live screen.
Zoom		Display the digital zoom screen
Sequence		Sequence.
Display Mode		Toggle between different display formats. The available formats are: full, 4x4, 3x3, 2x2 and PIP.
Display Mode	1 , 2 , 3 , 4 +  (QUAD)	PIP(1+Quad), 2x2(2+Quad), 3x3(3+Quad) and 4x4(4+Quad)
Enter		Select a highlighted item or completes an entry that you have made.
Spot Sequence	Spot No. + SPOT + ENTER	Toggle on and off sequence mode of the selected spot output.
Spot output	Spot No. + SPOT + camera No. + ENTER	Displays selected camera as spot output of the current DVR.
Full Screen	No. + 	Displays selected camera in the full-Screen Mode and enter the numbers in the login menu.
Cursor movement	 + Joystick	Up / Down / Left / Right control in the digital zoom. Left / Right control in the quad or 3x3 screen.
Cursor movement	Joystick	Up / Down / Left / Right control in the menu.
Shuttle		The Shuttle Ring operates in the Playback mode only. Turning the ring clockwise plays video forward. Turning the ring counterclockwise plays video backward.
Jog		The Jog Dial operates only when playback video has been paused. By turning the jog dial clockwise, you can play video forward image-by-image.

Appendix A- Short Cut Key

Short Cut Key	Function		
PRST	Pop up preset setup menu.		
TOUR	Pop up Tour setup menu.		
PTRN	Pop up Pattern setup menu.		
SCAN	Pop up Auto Scan setup menu.		
NO.+PGM +PRST	Store the current view at the selected number.		
Short Cut Key	Function	Short Cut Key	Function
1 + ON	Turn On Relay 1.	1 + OFF	Turn Off Relay.
2 + ON	Turn On Relay 2.	2 + OFF	Turn Off Relay.
3 + ON	Turn On Relay 3.	3 + OFF	Turn Off Relay.
4 + ON	Turn On Relay 4.	4 + OFF	Turn Off Relay.
7 + ON	Change FOCUS to AUTO	7 + OFF	Change FOCUS to manual
8 + ON	Change AE to AUTO	8 + OFF	Change AE to manual
9 + ON	Change Night Shot to AUTO		
10 + ON	Night Shot on (go to the manual mode)	10 + OFF	Night Shot off (go to the manual mode)
11 + ON	BLC on (AE auto mode)	11 + OFF	BLC off (AE auto mode)
12 + ON	Digital Zoom on (According to digital zoom setting)	12 + OFF	Digital Zoom off
13 + ON	Dome OSD on	13 + OFF	Dome OSD off
14 + ON	Dome Area Title Display on	14 + OFF	Dome Area Title Display off
15 + ON	View Direction on	15 + OFF	View Direction off
100 + ON	Shutter speed auto		
101 + ON	Shutter speed 1/4(PAL 1/3)sec		
102 + ON	Shutter speed 1/2 sec		
103 + ON	Shutter speed 1 sec		
104 + ON	WDR ON	104 + OFF	WDR off
105 + ON	Image Stabilizer ON	105 + OFF	Image Stabilizer off

* Some function may not operate according to the model.

Short Cut Key	Function	Short Cut Key	Function
150 + ON	Image Flip ON	150 + OFF	Image Flip off
151 + ON	Origin Check		
152 + ON	Place the camera in the 0° area horizontally.		
153 + ON	Go to the slow speed mode	153 + OFF	Go to the normal speed mode
154 + ON	Display System Information		
155 + ON	Flip the camera in the 180° area horizontally.		
250 + PRESET	Set the dome ID up to 3999		
888 + ENTER	Night Shot on (in the global mode only)		
999 + ENTER	Night Shot off (in the global mode only)		
For Keyboard controller			
777 + ENTER	Lock the keyboard controller. To unlock the keyboard, enter the password of the Keyboard.		

* Some function may not operate according to the model.

Appendix B- Trouble Shooting

If problems occur, verify the installation of the camera with the instructions in this manual and with other operating equipment. Isolate the problem to the specific piece of equipment in the system and refer to the equipment manual for further information.

Problem	Possible Solution
Joystick can't control system.	Check that the dome camera IDs are set properly. Check the polarity of the data line
Camera number does not match the multiplexer number.	Check the camera ID and insert the BNC cable into the proper input of the multiplexer.
Forgot password	Consult your supplier, distributor or service Center
Multiplexer & DVR can't work with the Joystick controller.	Check that the data cable for the multiplexer has the correct Pin configuration (1=1, 2=2, 3=3 8=8). Check the communication menu of Multiplexer.

Appendix C- OPTIONAL JUNCTION BOX

Description	Q'ty
Junction box (J-box)	1
3m 8pin cable (Unshielded cable)	2
M4 x L10 Self tapping screws	4

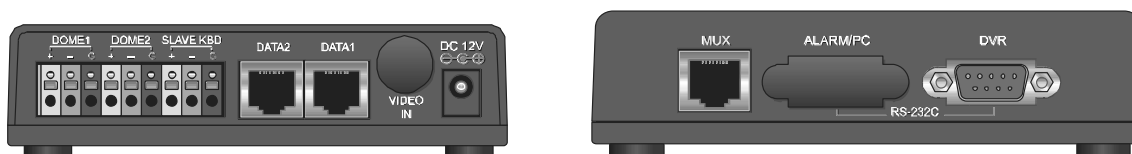

Figure -Front & Rear

NOTE: This junction box is not included in the keyboard box.

NOTE: Don't supply the power to the keyboard and the junction box together.

When you use the junction box with the keyboard, connect the power adaptor of the keyboard to the junction box.

Appendix D -SPECIFICATION

GENERAL	
Certification	CE EMC, FCC CLASS A
ELECTRICAL	
LCD	16 X 2 Line LCD
Joystick	Zoom handle Joystick
Input Voltage	12 VDC
Power Consumption	6W
Communications	RS-485/232 baud rate: 2400 ~38400 bps (default:9600bps)
Dome1 Port (RS-485)	Up to 127 dome cameras including 32 Alarm mode on.
Dome2 Port (RS-485)	Up to 127 dome cameras including 32 Alarm mode on / SLAVE KEYBOARD / DVR/MULTIPLEXER
RS-232	DVR / UPGRADE
MECHANICAL	
Dimension	15.9 X6.9 X 4.2(Unit : inch) : 405x176x107(Unit : mm)
Unit Weight	Approx 1.2 kg
Shipping Weight	Approx 2.2 kg
Shipping Size	19.7 X9.1 X 6.3(Unit : inch) : 500 x 230 x 160 mm
ENVIRONMENT	
Operating temperature	0°C to 50°C (32°F to 122°F)
Operating humidity	0 to 90%RH (non-condensing)
Storage temperature	-20°C to 60°C (-4°F to 140°F)

Specifications are subject to change without notice.

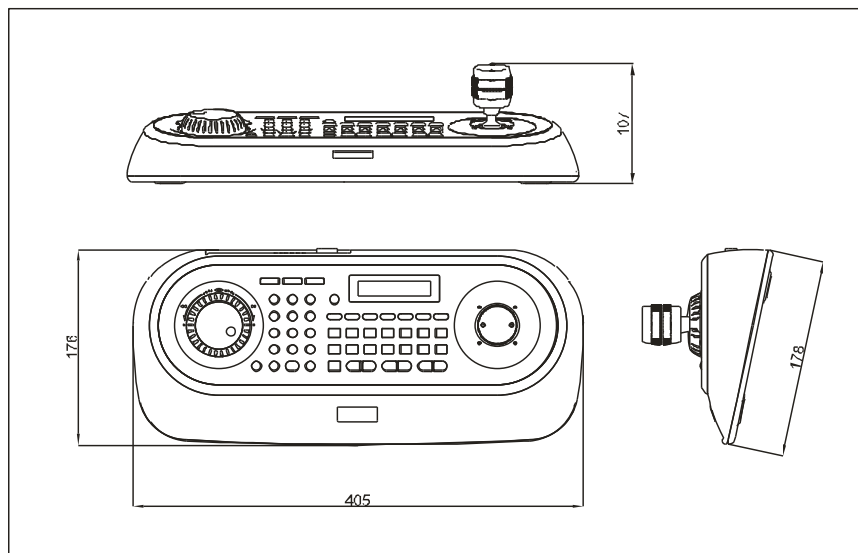

Figure – Dimension

MEMO

Keyboard Controller



I n s t r u c t i o n M A N U A L