

INSTRUCTION MANUAL
REHVDPTZ12-1

**REVO ELITE HD
12x Full-HD Mini-PTZ
NETWORK CAMERA**



Please read this manual thoroughly before use and keep it handy for future reference.

WARNING

TO REDUCE THE RISK OF FIRE OR ELECTRIC SHOCK, DO NOT EXPOSE THIS PRODUCT TO RAIN OR MOISTURE. DO NOT INSERT ANY METALLIC OBJECTS THROUGH THE VENTILATION GRILLS OR OTHER OPENINGS ON THE EQUIPMENT.

CAUTION

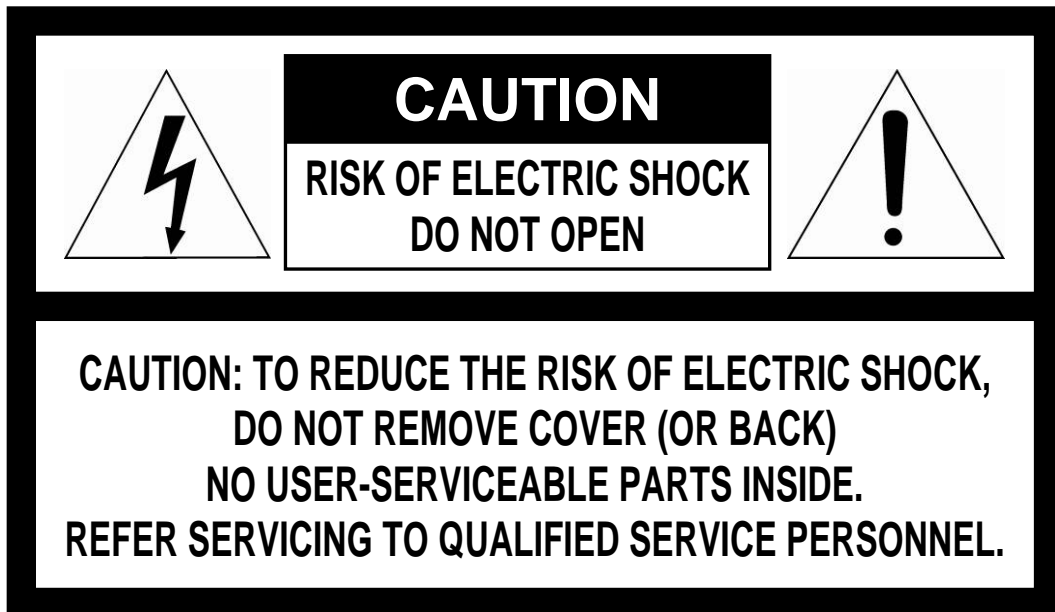

EXPLANATION OF GRAPHICAL SYMBOLS

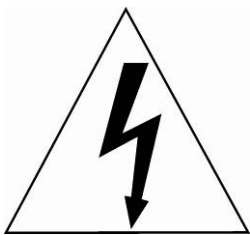

The lightning flash with arrowhead symbol, within an equilateral triangle, is intended to alert the user to the presence of uninsulated “dangerous voltage” within the product’s enclosure that may be of sufficient magnitude to constitute a risk of electric shock to persons.



The exclamation point within an equilateral triangle is intended to alert the user to the presence of important operating and maintenance (servicing) instructions in the literature accompanying the appliance.

FCC COMPLIANCE STATEMENT

This device complies with Part 15 of the FCC Rules. Operation is subject to the following two conditions: (1) this device may not cause harmful interference, and (2) this device must accept any interference received, including interference that may cause undesired operation.

FCC INFORMATION: This equipment has been tested and found to comply with the limits for a Class A digital device, pursuant to Part 15 of the FCC Rules. These limits are designed to provide reasonable protection against harmful interference when the equipment is operated in a commercial environment. This equipment generates, uses, and can radiate radio frequency energy and, if not installed and used in accordance with the instruction manual, may cause harmful interference to radio communications. Operation of this equipment in a residential area is likely to cause harmful interference in which case the user will be required to correct the interference at his own expense.

CAUTION: Changes or modifications not expressly approved by the party responsible for compliance could void the user's authority to operate the equipment.

This Class A digital apparatus complies with Canadian ICES-003.

Cet appareil numérique de la classe A est conforme à la norme NMB-003 du Canada.

CE COMPLIANCE STATEMENT

WARNING

This is a Class A product. In a domestic environment this product may cause radio interference in which case the user may be required to take adequate measures.

CAUTION
RISK OF EXPLOSION IF BATTERY IS REPLACED
BY AN INCORRECT TYPE.
DISPOSE OF USED BATTERIES ACCORDING
TO THE INSTRUCTIONS.

IMPORTANT SAFETY INSTRUCTIONS

1. Read these instructions.
2. Keep these instructions.
3. Heed all warnings.
4. Follow all instructions.
5. Do not use this apparatus near water.
6. Clean only with dry cloth.
7. Do not block any ventilation openings. Install in accordance with the manufacturer's instructions.
8. Do not install near any heat sources such as radiators, heat registers, stoves, or other apparatus (including amplifiers) that produce heat.
9. Do not defeat the safety purpose of the polarized or grounding-type plug. A polarized plug has two blades with one wider than the other. A grounding type plug has two blades and a third grounding prong. The wide blade or the third prong is provided for your safety. If the provided plug does not fit into your outlet, consult an electrician for replacement of the obsolete outlet.
10. Protect the power cord from being walked on or pinched particularly at plugs, convenience receptacles, and the point where they exit from the apparatus.
11. Only use attachments/accessories specified by the manufacturer.
12. Use only with the cart, stand, tripod, bracket, or table specified by the manufacturer, or sold with the apparatus. When a cart is used, use caution when moving the cart/apparatus combination to avoid injury from tip-over.
13. Unplug this apparatus during lightning storms or when unused for long periods of time.
14. Refer all servicing to qualified service personnel. Servicing is required when the apparatus has been damaged in any way, such as power-supply cord or plug is damaged, liquid has been spilled or objects have fallen into the apparatus, the apparatus has been exposed to rain or moisture, does not operate normally, or has been dropped.
15. **CAUTION – THESE SERVICING INSTRUCTIONS ARE FOR USE BY QUALIFIED SERVICE PERSONNEL ONLY. TO REDUCE THE RISK OF ELECTRIC SHOCK DO NOT PERFORM ANY SERVICING OTHER THAN THAT CONTAINED IN THE OPERATING INSTRUCTIONS UNLESS YOU ARE QUALIFIED TO DO SO.**
16. **Use satisfy clause 2.5 of IEC60950-1/UL60950-1 or Certified/Listed Class 2 power source only.**
17. ITE is to be connected only to PoE networks without routing to the outside plant.



TABLE OF CONTENTS

1. Description	7
1.1 Components	7
1.2 Key Features	8
2. Installation	9
2.1 Installation	9
2.2 Basic Configuration of Camera System	12
2.3 Connections	13
2.4 Network Connection & IP assignment	14
3. Operation	15
3.1 Access from a browser	15
3.2 Access from the internet	16
3.3 Setting the admin password over a secure connection	16
3.4 Live View Page	16
3.5 Network Camera Setup	18
3.5.1 Basic Configuration	18
1) Users	19
2) Network	20
3) Video & Image	21
4) Audio	23
5) Date & Time	24
3.5.2 Live View	25
3.5.3 Video & Image	25
1) Basic	25
2) Image	26
3) Auto Exposure	27
4) Day & Night	28
5) Auto Focus	29
6) DIS	30
7) Webcasting	30
3.5.4 Audio	31
3.5.5 Event	31
1) Event In	31
2) Event Out	35
3) Event Map	41
3.5.6 Dome Configuration	43
1) Preset	43

2) Tour	44
3) Motor Setup	45
4) RS485	46
5) View Angle	46
6) System Menu	47
7) Privacy Zone	48
3.5.7 System	49
1) Information	49
2) Security	49
3) Date & Time	51
4) Network	52
5) Language	60
6) Maintenance	61
7) Support	62
3.6 Help	64
3.7 Resetting to the factory default settings	64
4. Appendix	65
4.1 Troubleshooting	65
4.2 Alarm Connection	66
4.3 Preventive Maintenance	66
4.4 Product Specification	67
4.5 System Requirement for Web Browser	70
4.6 General Performance Considerations	70

1. Description

The network camera supports the network service for a sensor image with progressive scan, which can be monitored on a real-time screen regardless of distances and locations. By using its dedicated program, many users are able to have an access to the network camera at once or a single user can monitor various network cameras at the same time. It also enables users to play, store and retrieve a monitoring image by using a PC. All the settings and real-time monitoring screens are also provided through an access to the web.

The network camera is fully featured for security surveillance and remote monitoring needs. It is based on the DSP compression chip, and makes it available on the network as real-time, full frame rate Motion JPEG and H.264 video streams.

1.1 Components

The camera is designed with compact, small size, hard dome camera housing. The housing is constructed of aluminum, steel and plastic. The housing is designed to be mounted on a wall or a ceiling. The housing meets the Protection Classification IP66 standards for dust and moisture resistance.

* Dome Camera	1
* Installation Guide/CD	1
* Template Sheet	1
* Mounting Bracket	1
* Safety Lanyard	1
* Accessory Kit	1
1) Mounting screws (PH6 x 35.0)	(4)
2) Plastic anchors	(4)
3) O-Rings	(4)
4) Torx wrench	(1)
* Accessory Connector	1
1) 3-pin terminal block	(1)
2) 6-pin terminal block	(1)

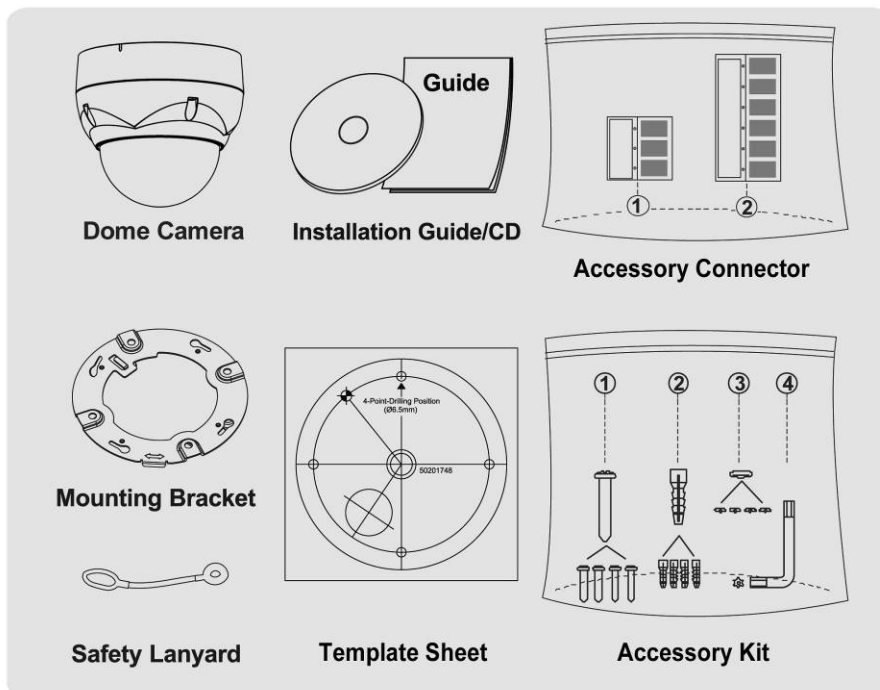

1.2 Key Features

- **Brilliant video quality**

The network camera offers the highly efficient H.264 video compression, which drastically reduces bandwidth and storage requirements without compromising image quality. Motion JPEG is also supported for increased flexibility.

- **Triple Streams**

The network camera can deliver triple video streams simultaneously at full frame rate in all resolutions up to 1920 x 1080 using Motion JPEG and H.264. This means that several video streams can be configured with different compression formats, resolutions and frame rates for different needs.

- **Image setting adjustment**

The network camera also enables users to adjust image settings such as contrast, brightness and saturation to improve images before encoding takes place.

- **Intelligent video capabilities**

The network camera includes intelligent capabilities such as enhanced video motion detection. The network camera's external inputs and outputs can be connected to devices such as sensors and relays, enabling the system to react to alarms and activate lights or open/close doors.

- **Improved Security**

The network camera logs all user access, and lists currently connected users. Also, its full frame rate video can be provided over HTTPS.

- **PoE (Power over Ethernet)**

This network camera can be powered through PoE, which simplifies installation since only one cable is needed for carrying power, as well as video controls.

- **ONVIF Certificate**

This is a global interface standard that makes it easier for end users, integrators, consultants, and manufacturers to take advantage of the possibilities offered by network video technology. ONVIF enables interoperability between different vendor products, increased flexibility, reduced cost, and future-proof systems.

2. Installation

2.1 Installation

The dome camera is for use in surface or pendent mounting applications, and the mounting member must be capable of supporting loads of up to 3.5 lb (1.6 kg). (Pendent mounting must use pendent mount accessory.)

The dome camera's mounting bracket should be attached to a structural object, such as hard wood, wall stud or ceiling rafter that supports the weight of the dome camera.

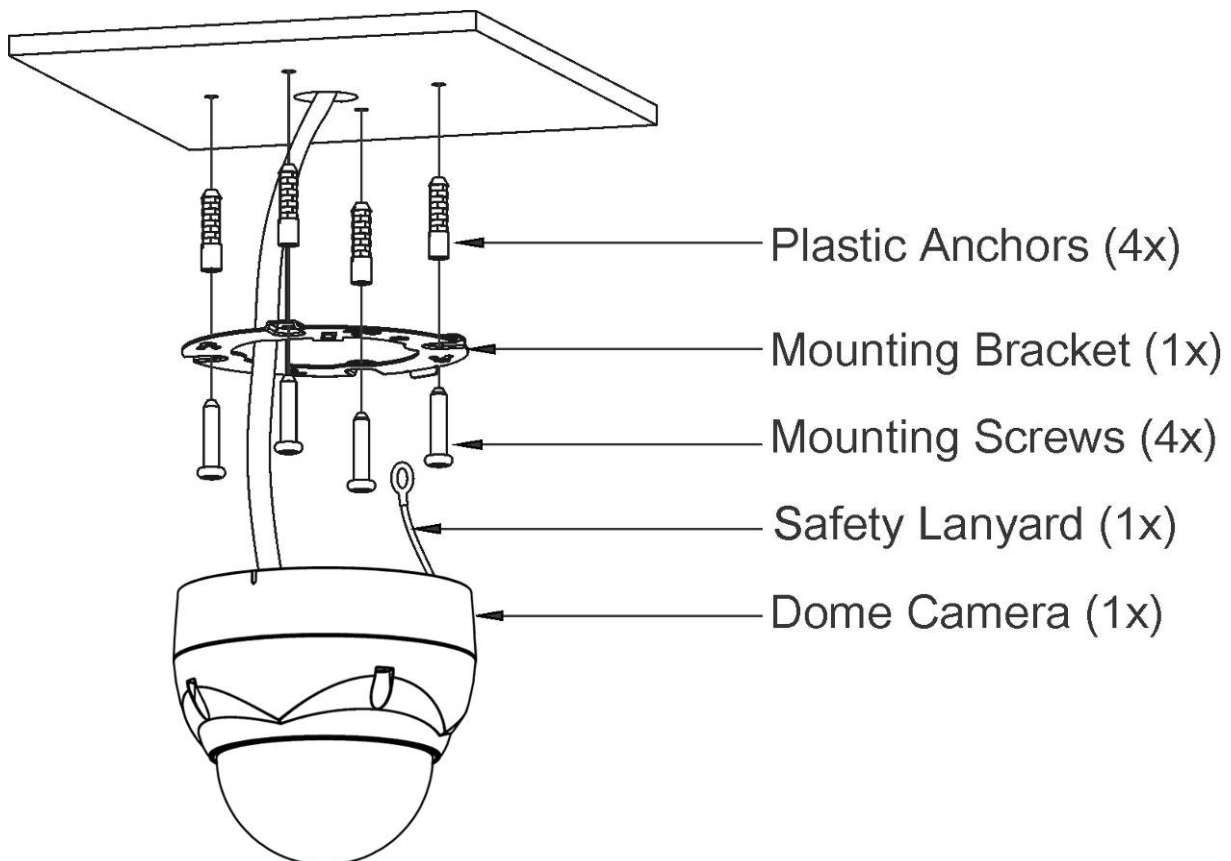

CAUTION: A silicone rubber sealant must be applied to seal the housing to secure waterproofing.

2.1.1 Locking Dome Camera

- Make screw holes on the ceiling using the supplied mounting Template Sheet (Figure A).
- Fix the Mounting Bracket to the ceiling using supplied Anchors (4x) and Mounting Screws (4x) (Figure B).
- Hook up the Safety Lanyard to the Safety Lanyard Hook of the Mounting Bracket (Figure C).
- Align the locking tab on the bracket and the locking slot on the base of the dome (Figure D).
- Turn the dome to the counterclockwise about 10 degree to the locked position (Figure E).

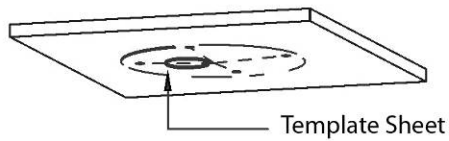

Figure A

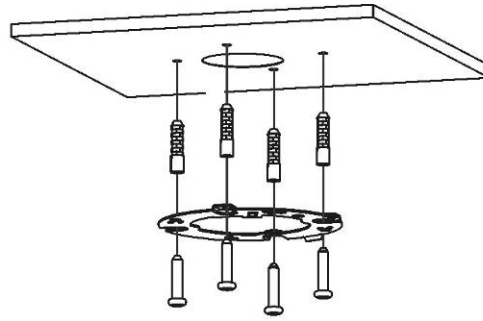

Figure B

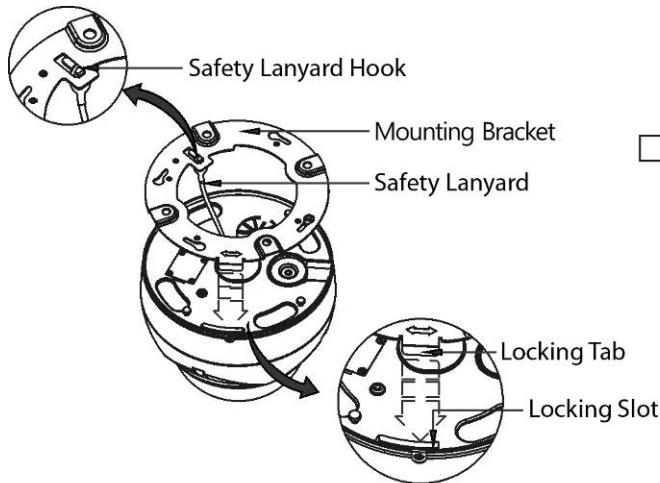

Figure C

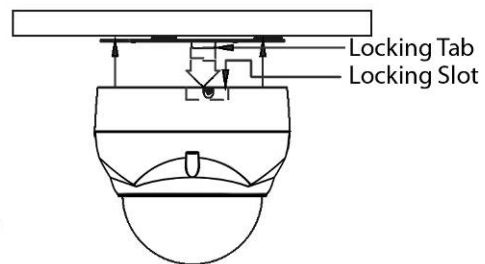

Figure D

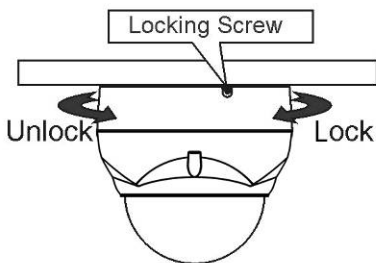

Figure E

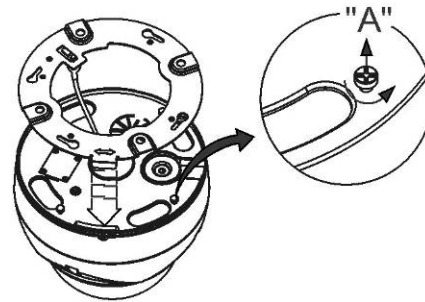
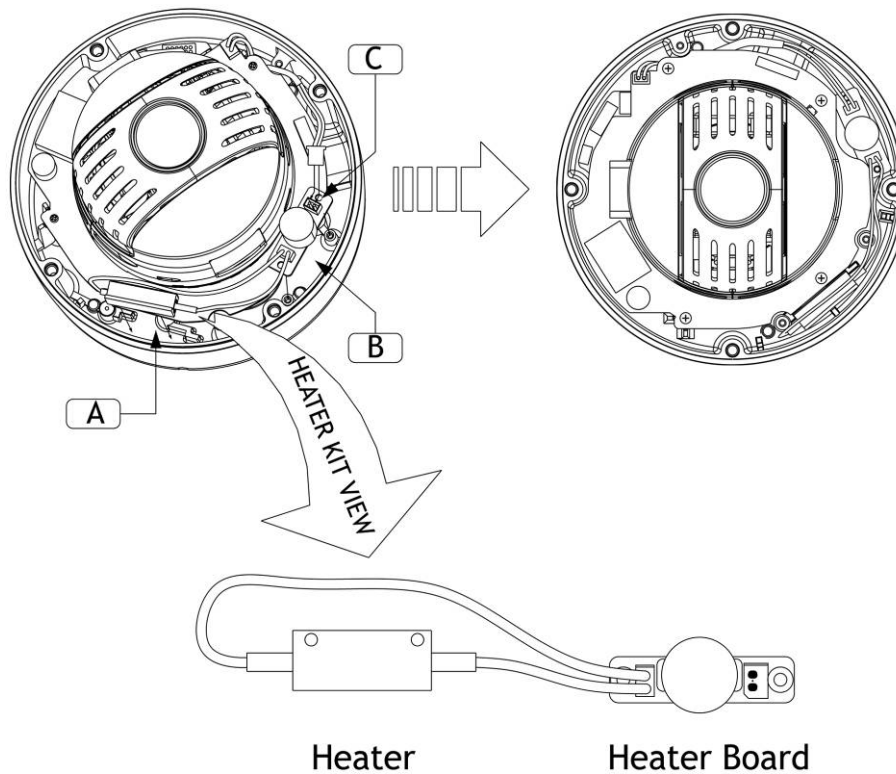

Figure F

CAUTION: Before installing mounting bracket to surface pre-adjust the four mounting screws "A" on the base of the dome camera to best match the mounting bracket locked position. Unscrew the locking screw on the side of the dome's base and fit the tab of the mounting bracket into the locking slot. Screws "A" should not be too tight or too loose when the dome is in the locked position. After setting the proper positions of screws "A" remove the mounting bracket and install it to the proper surface. If it is too difficult to lock the dome in position after the mounting bracket has been installed readjust the screws "A" by unscrewing them a small amount and try to install dome camera again.

2.1.2 Heater Kit Installation

- 1) Assemble the Heater board to two bosses with screws. Take a reference "B" in the bottom case as below.
- 2) Place the Heater in the slot "A". Heater cable should be placed away from the Main board.
- 3) Plug the power connector to the socket "C" (J1) of the Heater board.
- 4) 24VAC is recommended to use for the camera power for stable operation with heater kit.



• HEATER (IF APPLICABLE)

Power Supply	24VAC
Power Consumption	10W
Heater ON	at 59°F (15°C)
Heater OFF	at 77°F (25°C)

• POWER

Use satisfy clause 2.5 of IEC60950-1/UL60950-1 or Certified/Listed Class 2 power source only.

CAUTION: Please reset the camera after 30 minutes when installing it in situations colder than -10°C.

2.2 Basic Configuration of Camera System

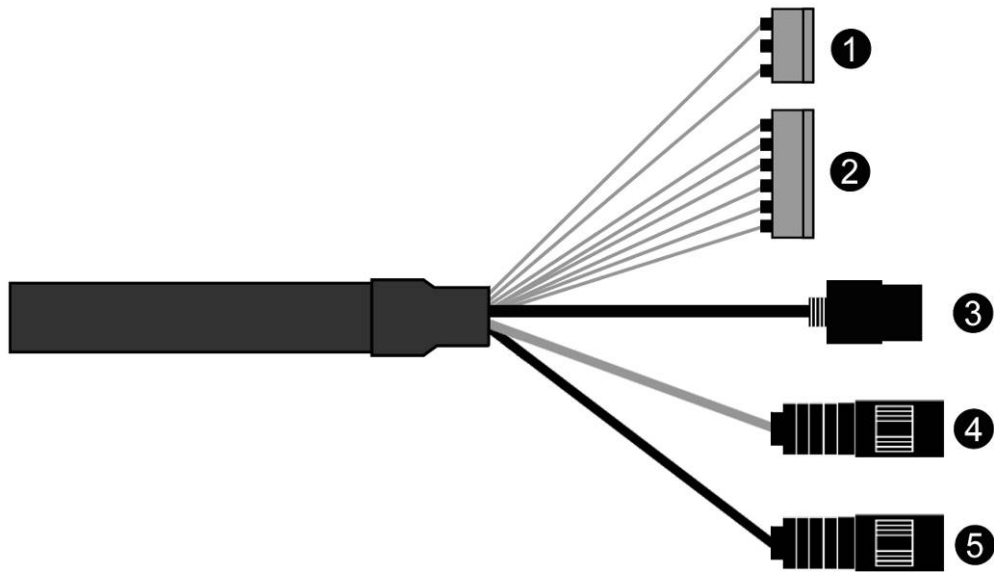

No.	Connector	Wire Color	Description
1	3-pin terminal block	RED	24VAC or 12VDC+
		WHITE	24VAC or 12VDC-
2	6-pin terminal block	PINK	GND
		GRAY	ALARM INPUT
		BROWN	GND
		YELLOW	ALARM OUTPUT
		GREEN	RS485+
		BLUE	RS485-
3	RJ-45	BLACK	Ethernet, RJ-45 port compatible with 10/100Mbps having PoE functionality.
4	STEREO	GRAY	AUDIO OUTPUT
5	STEREO	BLACK	AUDIO INPUT

The camera must be installed by qualified service personnel in accordance with all local and federal electrical and building codes.

2.3 Connections

- **Connecting the Network**

Connect a standard RJ-45 cable to the network port of the camera. Generally a cross-over cable is used for directly connection to PC, while a direct cable is used for connection to a hub.

- **Connecting Alarms**

- **AI (Alarm Input)**

You can use external devices to signal the camera to react on events. Mechanical or electrical switches can be wired to the AI (Alarm Input) and G (Ground) connectors.

- **G (Ground)**

NOTE: All the connectors marked G or GND are common.

Connect the ground side of the alarm input and/or alarm output to the G (Ground) connector.

- **AO (Alarm Output)**

The camera can activate external devices such as buzzers or lights. Connect the device to the AO (Alarm Output) and G (Ground) connectors.

- **Connecting to the RS485**

The camera can be controlled remotely by an external device or control system, such as a control keyboard, using RS485 half-duplex serial communications signals.

- **Connecting the Power**

Connect power of 12VDC or 24VAC 1.5A for the camera.

When using a 12VDC adapter, connect the positive (+) pole to the '+' position and the negative (-) pole to the '-' position.

Use satisfy clause 2.5 of IEC60950-1/UL60950-1 or Certified/Listed Class 2 power source only.

- Be careful not to reverse the polarity when you connect the power cable.

- You can also use a router featuring PoE (Power over Ethernet) to supply power to the camera.

- If PoE and 12VDC are both applied, this camera will get supplied with power from PoE.

- 24VAC is recommended to use for the camera power for stable operation with heater kit. If using PoE, the heater will not operate at all.

2.4 Network Connection & IP assignment

The camera supports the operation through the network. When a camera is first connected to the network, it is necessary to allocate an IP address to the device with the “SmartManager” utility on the CD. (Default IP 192.168.30.220)

- 1) Connect the network camera/device to the network and power up.
- 2) Start SmartManager utility (Start > All programs > SmartManager > SmartManager). The main window will display, and after a short while any network devices connected to the network will be displayed in the list.

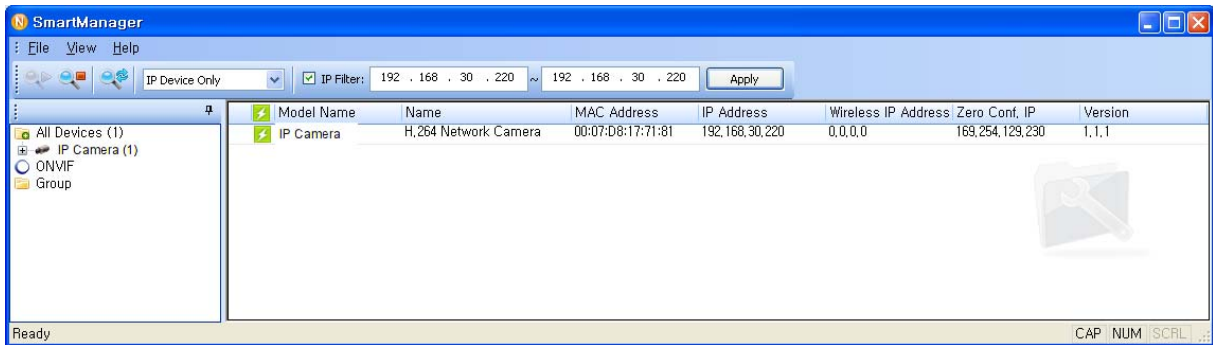

- 3) Select the camera on the list and click right button of the mouse. You can see the pop-up menu as below.

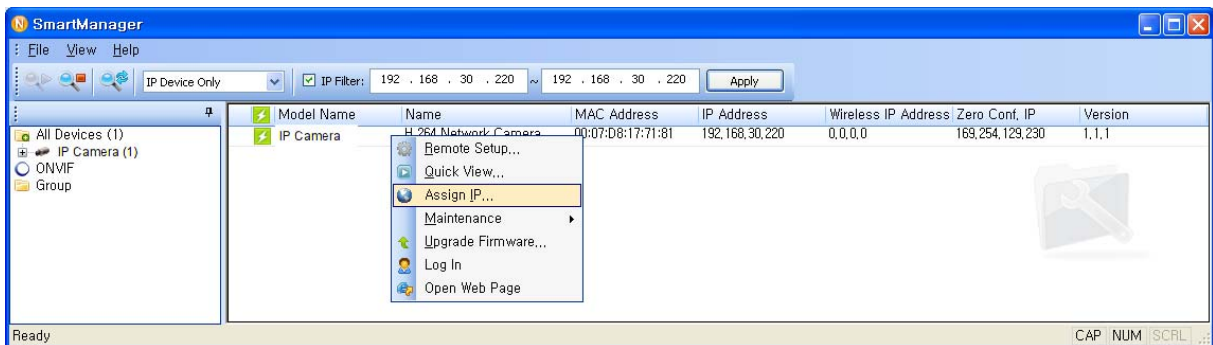

- 4) Select Assign IP Address. The Assign IP window will display. Enter the required IP address.

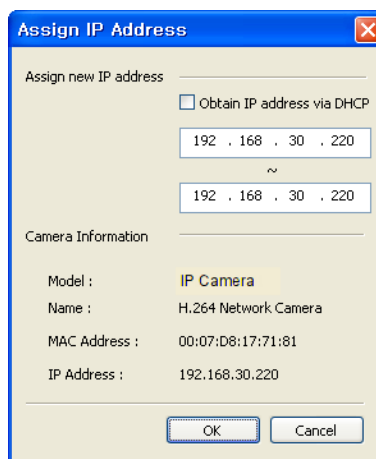

NOTE: For more information, refer to the SmartManager User's Manual.

3. Operation

The network camera can be used with Windows® operating system and browsers. The recommended browsers are Internet Explorer®, Safari®, Firefox®, Opera™ and Google® Chrome® with Windows.

NOTE: To view streaming video in Microsoft Internet Explorer, set your browser to allow ActiveX controls.

3.1 Access from a browser

- 1) Start a browser (Internet Explorer).
- 2) Enter the IP address or host name of the network camera in the Location/Address field of your browser.
- 3) You can see a starting page. Click **Live View** or **Setup** to enter web page.

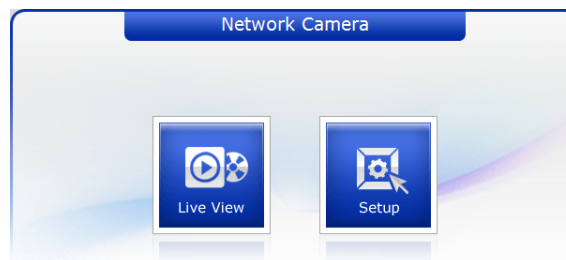

- 4) The network camera's **Live View** page appears in your browser.

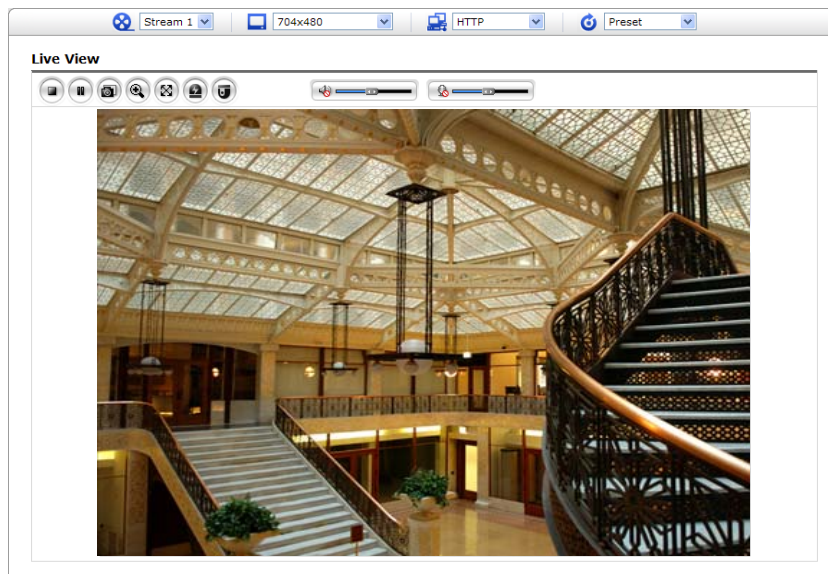

3.2 Access from the internet

Once connected, the network camera is accessible on your local network (LAN). To access the network camera from the Internet you must configure your broadband router to allow incoming data traffic to the network camera. To do this, enable the NAT traversal feature, which will attempt to automatically configure the router to allow access to the network camera. This is enabled from Setup > System > Network > NAT. For more information, please see “3.5.7 System > Network > NAT” of User's Manual.

3.3 Setting the admin password over a secure connection

To gain access to the product, the password for the default administrator user must be set. This is done in the “Admin Password” dialog, which is displayed when the network camera is accessed for the setup at the first time. Enter your admin name and password, set by the administrator.



NOTE: The default administrator user name and password is “admin”. If the password is lost, the network camera must be reset to the factory default settings. Please see “Resetting to the factory default settings”.

To prevent network eavesdropping when setting the admin password, this can be done via an encrypted HTTPS connection, which requires an HTTPS certificate (see **NOTE** below).

To set the password via a standard HTTP connection, enter it directly in the first dialog shown below. To set the password via an encrypted HTTPS connection, please see “3.5.7 System > Security > HTTPS” of User's Manual.

NOTE: HTTPS (Hypertext Transfer Protocol over SSL) is a protocol used to encrypt the traffic between web browsers and servers. The HTTPS certificate controls the encrypted exchange of information.

3.4 Live View Page

The Live View page comes in several screen modes: 1920x1080, 1280x1024, 1280x720, 704x576, 704x480, 640x480 and 320x240. Users are allowed to select the most suitable one out of those modes. Adjust the mode in accordance with your PC specifications and monitoring purposes.

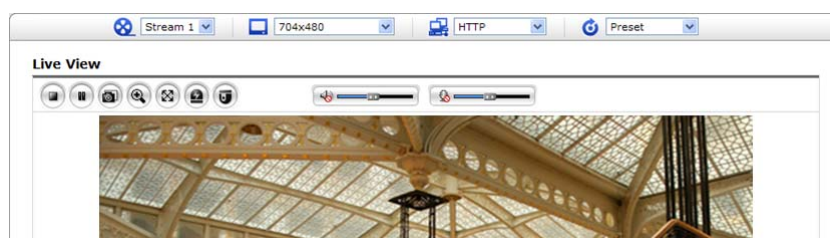

1) General controls



Live View Page



Setup Page



Help Page

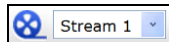

The video drop-down list allows you to select a customized or pre-programmed video stream on the Live View page. Stream profiles are configured under Setup > Basic Configuration > Video & Image. For more information, please see “3.5.1 Basic Configuration > Video & Image” of User’s Manual.

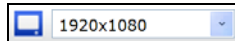

The resolution drop-down list allows you to select the most suitable one out of video resolutions to be displayed on Live View page.

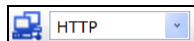

The protocol drop-down list allows you to select which combination of protocols and methods to use depending on your viewing requirements, and on the properties of your network.

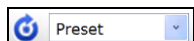

The preset drop-down list allows you to select the preset number for the PTZ camera being used. This icon is inactivated if the PTZ settings are not set.

2) Control toolbar

The live viewer toolbar is available in the web browser page only. It displays the following buttons:



The **Stop** button stops the video stream being played. Pressing the key again toggles the start and stop. The **Start** button connects to the network camera or starts playing a video stream.



The **Pause** button pauses the video stream being played.



The **Snapshot** button takes a snapshot of the current image. The location where the image is saved can be specified.



The **Digital Zoom** button activates a zoom-in or zoom-out function for video image on the live screen.



The **Full Screen** button causes the video image to fill the entire screen area. No other windows will be visible. Press the 'Esc' button on the computer keyboard to cancel full screen view.



The **Manual Trigger** button activates a pop-up window to manually start or stop the event.



The **PTZ** button activates a pop-up window for Pan, Tilt and Zoom control.



Use this scale to control the volume of the speakers.



Use this scale to control the volume of the microphone.



Use this scale to control the volume of the speakers and microphones.

3) Video Streams

The network camera provides several images and video stream formats. Your requirements and the properties of your network will determine the type you use.

The Live View page in the network camera provides access to H.264 and Motion JPEG video streams, and to the list of available video streams. Other applications and clients can also access these video streams/images directly, without going via the Live View page.

3.5 Network Camera Setup

This section describes how to configure the network camera, and is intended for product Administrators, who have unrestricted access to all the Setup tools; and Operators, who have access to the settings for Basic Configuration, Live View, Video & Image, Audio, Event, Dome Configuration, System

You can configure the network camera by clicking Setup in the top right-hand corner of the Live View page. Click on this page to access the online help that explains the setup tools.

When accessing the network camera for the first time, the “Admin Password” dialog appears. Enter your admin name and password, set by the administrator.



NOTE: If the password is lost, the network camera must be reset to the factory default settings. Please see “Resetting to the Factory Default Settings”.

3.5.1 Basic Configuration

You can see the device information in this information page.

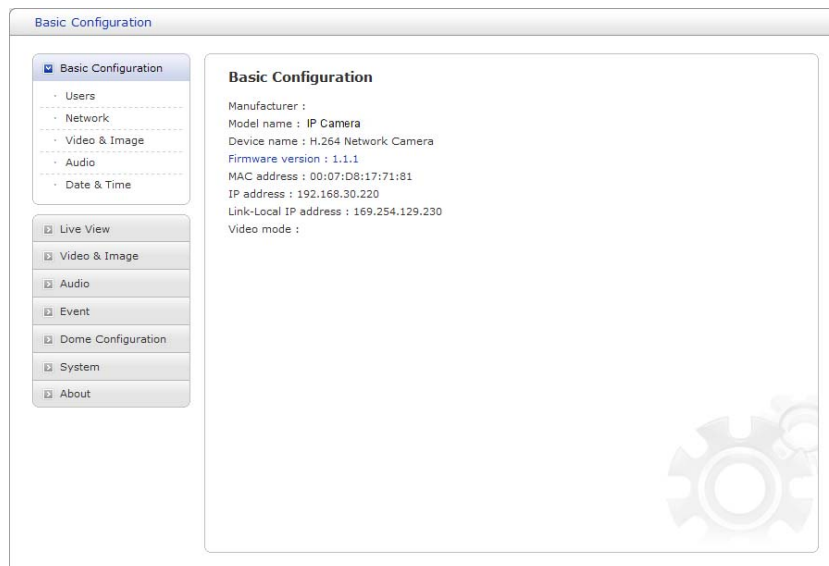

1) Users

User access control is enabled by default. An administrator can set up other users, by giving these user names and passwords. It is also possible to allow anonymous viewer login, which means that anybody may access the Live View page, as described below:

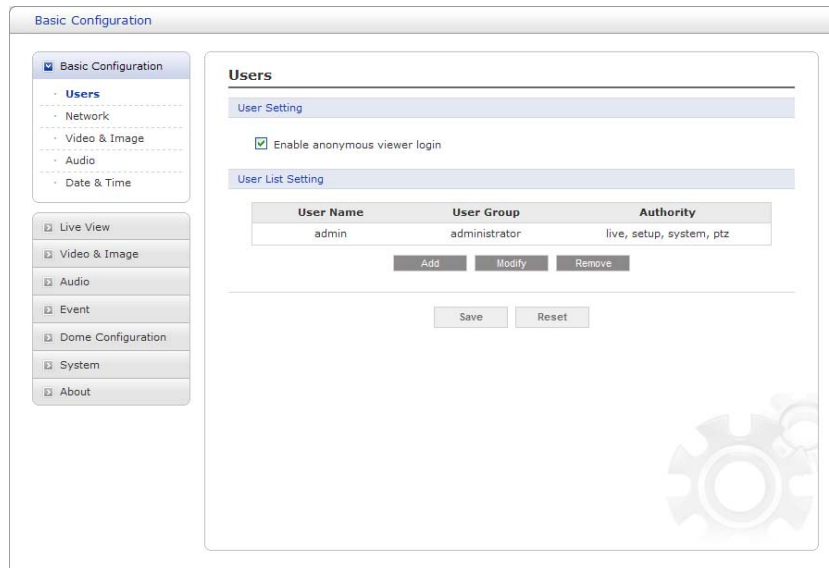

The **user list** displays the authorized users and user groups (levels):

User Group	Authority
Guest	Provides the lowest level of access, which only allows access to the Live View page.
Operator	An operator can view the Live View page, create and modify events, and adjust certain other settings. Operators have no access to System Options.
Administrator	An administrator has unrestricted access to the Setup tools and can determine the registration of all other users.

- **Enable anonymous viewer login:** Check the box to use the webcasting features. Refer to "3.5.3 Video & Image" for more details.

2) Network

The network camera supports both IP version 4 and IP version 6. Both versions may be enabled simultaneously, and at least one version must always be enabled. When using IPv4, the IP address for the network camera can be set automatically via DHCP, or a static IP address can be set manually. If IPv6 is enabled, the network camera an IP address according to the configuration in the network router. There is also the option of using the Internet Dynamic DNS Service. For more information on setting the network, please see “3.5.7 System > Network > Basic”.

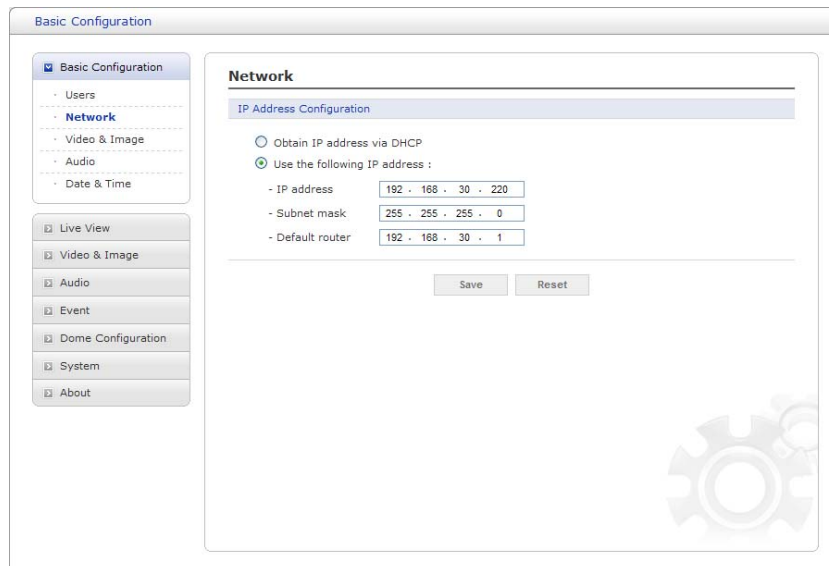

The screenshot shows a web interface for 'Basic Configuration'. On the left is a navigation menu with options: Basic Configuration (selected), Users, Network, Video & Image, Audio, Date & Time, Live View, Video & Image, Audio, Event, Dome Configuration, System, and About. The main content area is titled 'Network' and contains 'IP Address Configuration'. It has two radio buttons: 'Obtain IP address via DHCP' (unselected) and 'Use the following IP address:' (selected). Below these are three input fields: 'IP address' (192.168.30.220), 'Subnet mask' (255.255.255.0), and 'Default router' (192.168.30.1). At the bottom of the configuration area are 'Save' and 'Reset' buttons.

- **Obtain IP address via DHCP:** Dynamic Host Configuration Protocol (DHCP) is a protocol that lets network administrators centrally manage and automate the assignment of IP addresses on a network. DHCP is enabled by default. Although a DHCP server is mostly used to set an IP address dynamically, it is also possible to use it to set a static, known IP address for a particular MAC address.
- **Use the following IP address:** To use a static IP address for the network camera, check the radio button and then make the following settings:
 - **IP address:** Specify a unique IP address for your network camera.
 - **Subnet mask:** Specify the mask for the subnet the network camera is located on.
 - **Default router:** Specify the IP address of the default router (gateway) used for connecting devices attached to different networks and network segments.

NOTES:

1. DHCP should only be enabled if using dynamic IP address notification, or if your DHCP server can update a DNS server, which then allows you to access the network camera by name (host name). If DHCP is enabled and you cannot access the unit, you may have to reset it to the factory default settings and then perform the installation again.
2. The ARP/Ping service is automatically disabled two minutes after the unit is started, or as soon as an IP address is set.
3. Pinging the unit is still possible when this service is disabled.

3) Video & Image

The screenshot displays the 'Basic Configuration' window for 'Video & Image' settings. On the left, a sidebar lists navigation options: Basic Configuration (selected), Users, Network, Video & Image, Audio, Date & Time, Live View, Video & Image, Audio, Event, Dome Configuration, System, and About. The main area is titled 'Video & Image' and contains four sections: 'Sensor Setting', 'Stream 1 Setting', 'Stream 2 Setting', and 'Stream 3 Setting'. Each section has a set of configuration options. 'Sensor Setting' includes 'Capture mode' (1920x1080 Max. 30fps). 'Stream 1 Setting' includes 'Codec' (H.264 Baseline Profile), 'Resolution' (1920x1080), 'Bitrate control' (CBR), 'Bitrate' (4000 [Kbps]), 'Framerate' (30), and 'GOP size' (30 [1...60]). 'Stream 2 Setting' includes 'Codec' (MJPEG), 'Resolution' (640x480), 'Framerate' (30), and 'Quality' (50 [1...100]). 'Stream 3 Setting' includes 'Codec' (H.264 Baseline Profile), 'Resolution' (640x480), 'Bitrate control' (CBR), 'Bitrate' (2000 [Kbps]), 'Framerate' (30), and 'GOP size' (30 [1...60]). At the bottom right, there are 'Save' and 'Reset' buttons.

- **Sensor Setting:**

- **Capture mode:** Use can select video frame rate at either 60/50fps or 30/25fps of resolution 1920x1080.

- **Stream 1 Setting:**

- **Codec:** The codec settings are separated into H.264. H.264 is also known as MPEG-4 Part 10. This is the new generation compression standard for digital video. This function offers higher video resolution than Motion JPEG or MPEG-4 at the same bit rate and bandwidth, or the same quality video at a lower bit rate.
- **Profile:** There are 3 pre-programmed stream profiles available for quick set-up. Choose the form of video encoding you wish to use from the drop-down list:
 - * **H.264 HP (High Profile):** Primary profile for broadcast and disc storage applications, particularly for high-definition television applications (for example, this is the profile adopted by the [Blu-ray Disc](#) storage format and the [DVB](#) HDTV broadcast service).
 - * **H.264 MP (Main Profile):** Primary profile for low-cost applications that require additional error robustness, this profile is used rarely in videoconferencing and mobile applications; it does add additional error resilience tools to the Constrained Baseline Profile. The importance of this profile is fading after the Constrained Baseline Profile has been defined.
 - * **H.264 BP (Baseline Profile):** Originally intended as the mainstream consumer profile for broadcast and storage applications, the importance of this profile faded when the High Profile was developed for those applications.
- **Resolution:** This enables users to determine a basic screen size when having an access through the Web Browser or PC program. The screen size control comes in seven modes like 1920x1080, 1280x1024, 1280x720, 704x576, 704x480, 640x480 and 320x240.

Users can reset the selected screen size anytime while monitoring the screen on a real-time basis.

- **Bit rate control:** Limiting the maximum bit rate helps control the bandwidth used by the H.264 video stream. Leaving the Maximum bit rate as unlimited maintains consistently good image quality but increases bandwidth usage when there is more activity in the image. Limiting the bit rate to a defined value prevents excessive bandwidth usage, but images are lost when the limit is exceeded.

NOTE: The maximum bit rate can be used for both variable and constant bit rates.

The bit rate can be set as Variable Bit Rate (VBR) or Constant Bit Rate (CBR). VBR adjusts the bit rate according to the image complexity, using up bandwidth for increased activity in the image, and less for lower activity in the monitored area.

CBR allows you to set a fixed target bit rate that consumes a predictable amount of bandwidth. As the bit rate would usually need to increase for increased image activity, but in this case cannot, the frame rate and image quality are affected negatively. To partly compensate for this, it is possible to prioritize either the frame rate or the image quality whenever the bit rate needs to be increased. Not setting a priority means the frame rate and image quality are equally affected.

- **Bit rate:** When it is necessary to adjust a smooth transmission status according to network situations, users can increase the compressibility to carry out the network transmission stably. On the other hand, when it is necessary to maintain a detailed monitoring screen by enhancing the image quality, users can do so by decreasing the compressibility. In each case, please adjust this function according to the network status and monitoring purposes.
- **Frame rate:** Upon the real-time play, users should select a frame refresh rate per second. If the rate is high, the image will become smooth. On the other hand, if the rate is low, the image will not be natural but it can reduce a network load.
- **GOP size:** Select the GOP (Group of Picture) size. If users want to have a high quality of fast image one by one, please decrease the value. For the purpose of general monitoring, please do not change a basic value. Such act may cause a problem to the system performance. For the details of GOP setting, please contact the service center.
- **Stream 2 Setting:** Sometimes the image size is large due to low light or complex scenery. Adjusting the frame rate and quality helps to control the bandwidth and storage used by the Motion JPEG video stream in these situations. Limiting the frame rate and quality optimizes bandwidth and storage usage, but may give poor image quality. To prevent increased bandwidth and storage usage, the Resolution, Frame rate, and Frame Quality should be set to an optimal value.
 - **MJPEG Resolution:** Same as the stream 1 settings.
 - **MJPEG Frame rate:** Same as the stream 1 settings.
 - **MJPEG Quality:** Select the picture quality. If users want to have a high quality of fast image one by one, please decrease the value. For the purpose of general monitoring, please do not change a basic value. Such act may cause a problem to the system performance.
- **Stream 3 Setting:** Same as the Stream 1 Setting.

When satisfied with the settings, click the **Save** button, or click the **Reset** button to revert to previously saved settings.

4) Audio

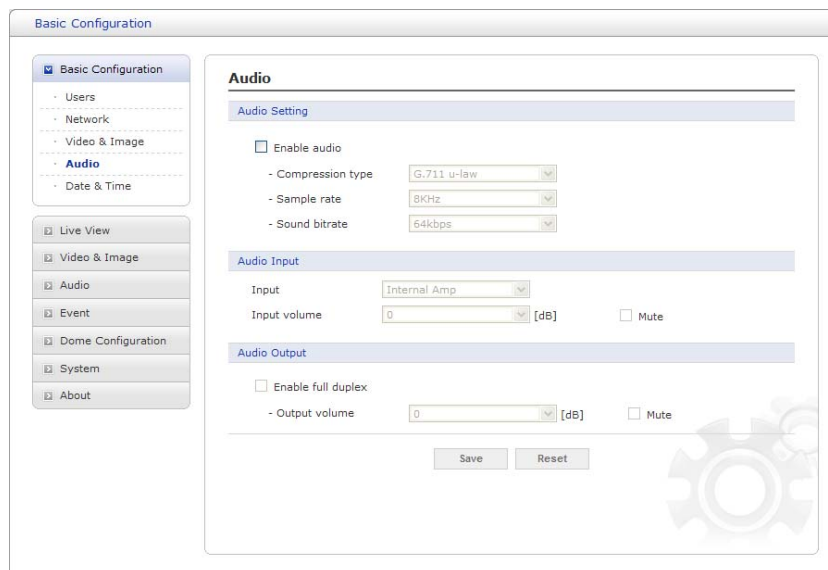

The network camera can transmit audio to other clients using an external microphone and can play audio received from other clients by attaching a speaker. The Setup page has an additional menu item called Audio, which allows different audio configurations, such as full duplex and simplex.

- **Audio Setting:**

- **Enable audio:** Check the box to enable audio in the video stream.
- **Compression type:** Select the desired audio Compression format, G.711.
- **Sample rate:** Select the required Sample rate (number of times per second the sound is sampled). The higher the sample rate, the better the audio quality and the greater the bandwidth required.
- **Sound bit rate:** Depending on the selected encoding, set the desired audio quality (bit rate). The settings affect the available bandwidth and the required audio quality.

- **Audio Input:** Audio from an external line source can be connected to the STEREO Jack I/O of the network camera.

- **Input volume:** If there are problems with the sound input being too low or high, it is possible to adjust the input gain for the microphone attached to the network camera.

- **Audio Output:**

- **Enable full duplex:** Check the box to enable Full Duplex mode. This means that you can transmit and receive audio (talk and listen) at the same time, without having to use any of the controls. This is just like having a telephone conversation.

This mode requires that the client PC has a sound card with support for full-duplex audio.

Uncheck the box enable Simplex mode. The simplex mode only transmits audio from the network camera to any web client. It does not receive audio from other web clients.

- **Output volume:** If the sound from the speaker is too low or high it is possible to adjust the output gain for the active speaker attached to the network camera.

When satisfied with the settings, click the **Save** button, or click the **Reset** button to revert to previously saved settings.

5) Date & Time

The screenshot shows the 'Basic Configuration' window with the 'Date & Time' tab selected. The 'Current Server Time' section shows the date as 2013-11-13 and time as 11:30:23. The 'New Server Time' section allows selecting a time zone from a dropdown menu (currently set to '(GMT) Greenwich Mean Time : Dublin, Edinburgh, Lisbon, London') and a checkbox for 'Automatically adjusts for daylight saving time changes'. The 'Time mode' section has three radio button options: 'Synchronize with computer time' (selected), 'Synchronize with NTP server' (with fields for 'NTP server' and 'NTP Interval'), and 'Set manually' (with fields for 'Date' and 'Time'). The 'Date & Time Format' section has dropdown menus for 'Date Format' (set to 'YYYY-MM-DD') and 'Time Format' (set to '24 Hour'). 'Save' and 'Reset' buttons are located at the bottom of the configuration area.

- **Current Server Time:** This displays the current date and time (24h clock). The time can be displayed in 12h clock format in the overlay (see below).
- **New Server Time:** Select your time zone from the drop-down list. If you want the server clock to automatically adjust for daylight saving time, select “Automatically adjustment for daylight saving time changes”.

From the Time mode section, select the preferred method to use for setting the time:

- **Synchronize with computer time:** sets the time from the clock on your computer.
 - **Synchronize with NTP Server:** the video encoder will obtain the time from an NTP server every 60 minutes.
 - **Set manually:** this option allows you to manually set the time and date.
- **Data & Time Format:** Specify the formats for the date and time (12h or 24h) displayed in the video streams.

Select Date & Time format from the drop-down list.

- **Date Format:** Specify the date format. YYYY: Year, MM: Month, DD: Day
- **Time Format:** Specify the date format. 24 Hour or 12 Hour

3.5.2 Live View

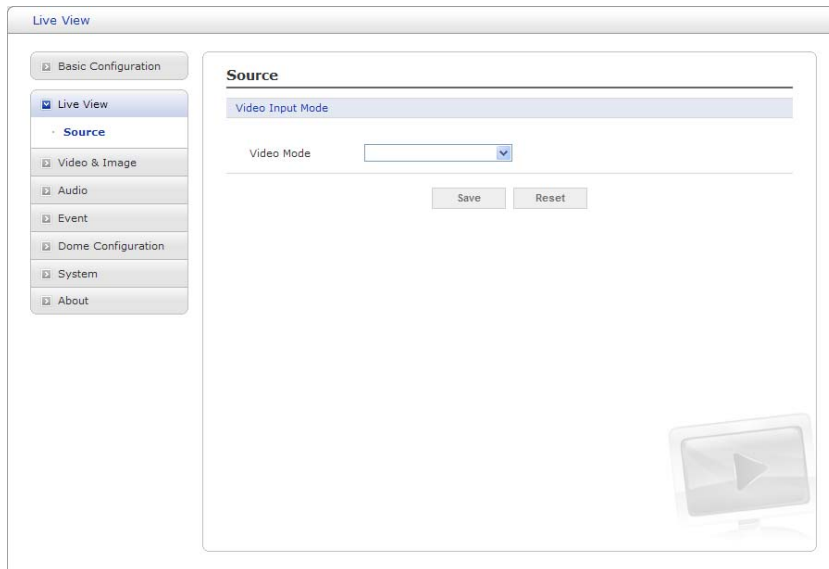

- **Video Input Mode:**

- **Video Mode:** Choose Video Mode you wish to use from the drop-down list: NTSC or PAL

- NOTE:** This function may not be applicable, depending on the model.

3.5.3 Video & Image

1) Basic

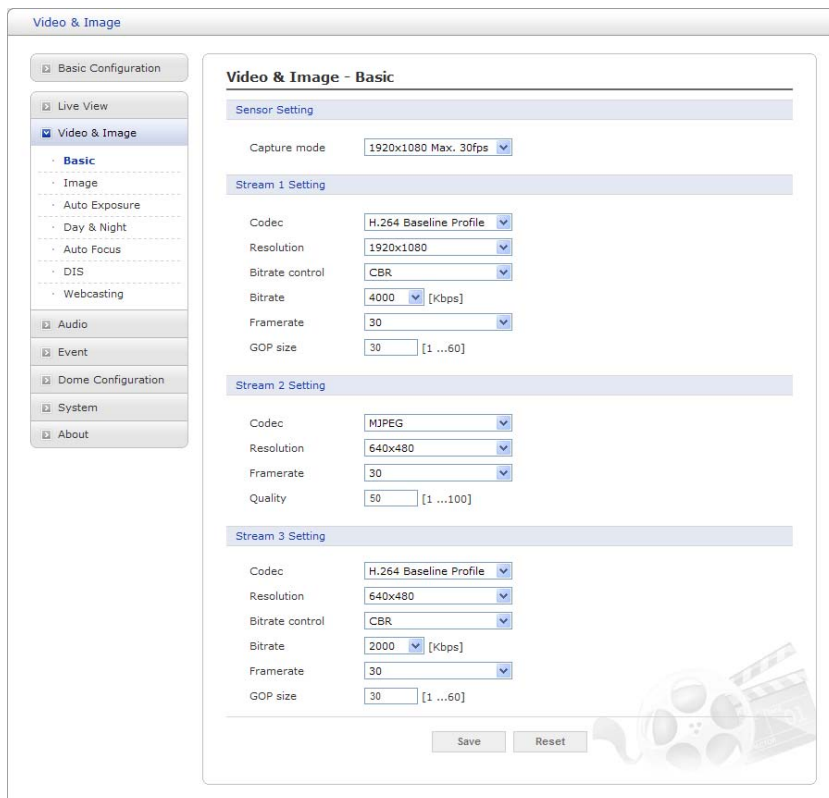

Refer to “3.5.1 Basic Configuration > Video & Image” for more details.

2) Image

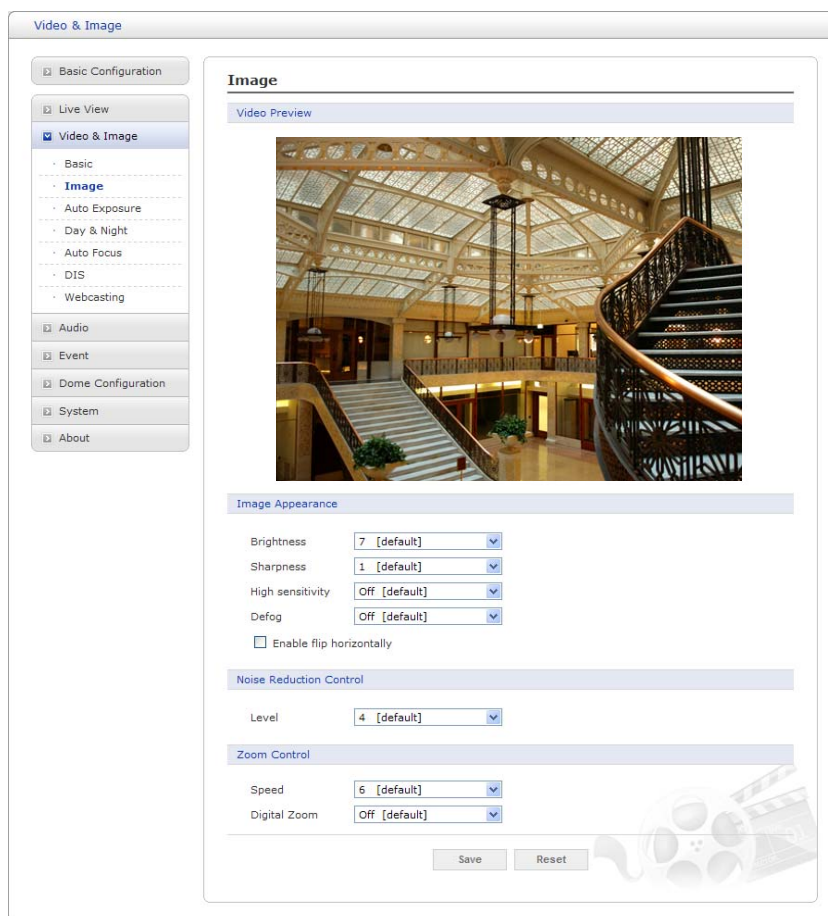

- **Image Appearance:**

- **Brightness:** The image brightness can be adjusted in the range 1 ~ 12, where a higher value produces a brighter image.
- **Sharpness:** Controls the amount of sharpening applied to the image. A sharper image might increase image noise especially in low light conditions. A lower setting reduces image noise, but the image would be less sharp.
- **High sensitivity:** Produce brighter image in low light environment.
- **Defog:** Produce clearer image in hazy environment.
- **Enable flip horizontally:** Flip the camera image upside down.

- **Noise Reduction Control:** The NR (Noise Reduction) function removes noise to provide clearer image. In bright conditions, changing the NR level may not affect the image quality.

- **Level:** The level can be adjusted in the range 1 ~ 10 and Off.

- **Zoom Control:**

- **Speed:** The speed can be adjusted in the range 1 ~ 8.
- **Digital Zoom:** Select On or Off.

3) Auto Exposure

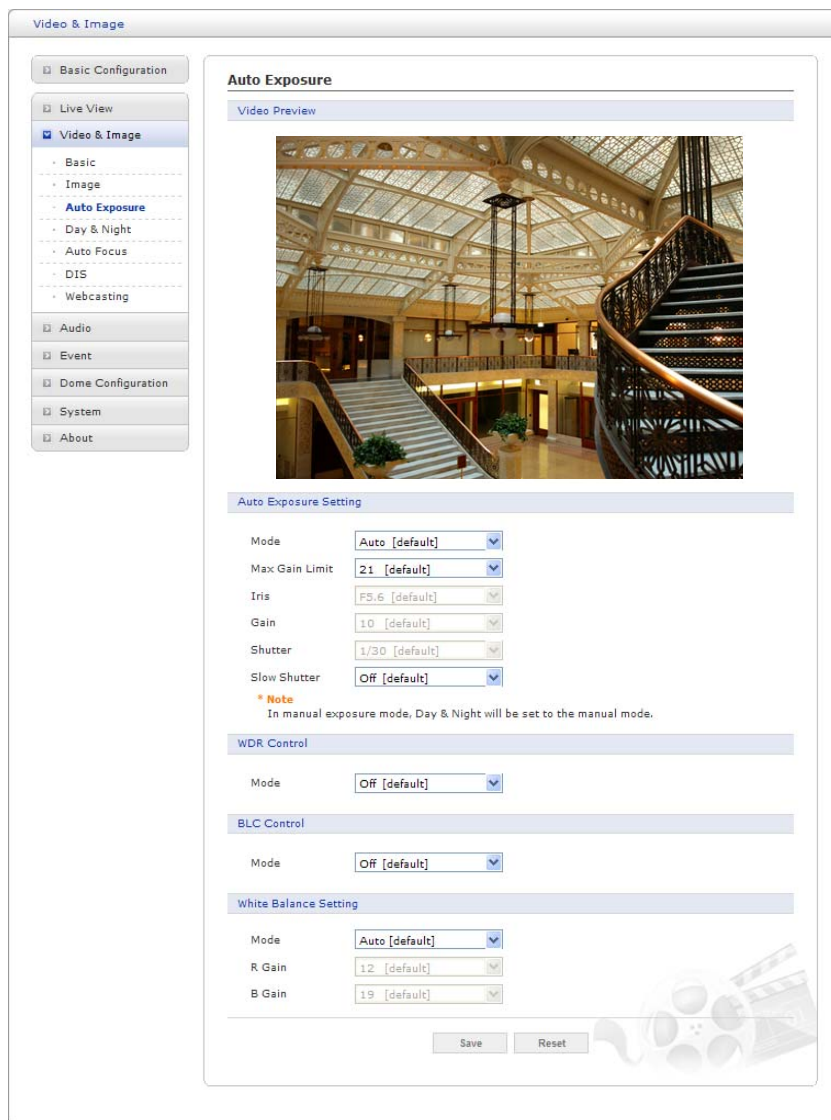

- **Auto Exposure Setting:** Exposure is the amount of light detected by the camera sensor. A scene with correct exposure settings has adequate detail and contrast between white and dark values. An image with too little or too much exposure may lose detail in the scene. The camera features Auto and Manual Exposure Settings.
 - **Mode:** Support Exposure modes to control the amount of light detected by the camera sensor base on settings for light conditions.
 - **Max Gain Limit:** Controls the upper limit of the gain which the camera can control. This is only available if Exposure mode is set to Auto.
 - **Iris:** Controls the camera iris. This is only available if Exposure mode is set to Manual.
 - **Gain:** Increasing exposure gain increases the brightness of image, but it also increases the amount of noise in the image. This is only available if Exposure mode is set to Manual.
 - **Shutter:** Controls the electronic shutter speed. This is only available if Exposure mode is set to Manual.
 - **Slow Shutter:** The camera can lower the shutter speed electronically to get brighter image when the brightness drops. This is only available if Exposure mode is set to Auto.

- **WDR Control:** Wide Dynamic Range (WDR) improves video exposure quality in scenes with high contrast between bright and dark areas, for example, if a shady area and a bright light area are in the same scene.
 - **Mode:** Select On or Off.
- **BLC Control:** Backlight Compensation (BLC) corrects the exposure of the subjects that are in a bright light source.
 - **Mode:** Select On or Off.
- **White Balance Setting:** Adjustments in the color hue (red and blue) gains for a camera so that true white appears white in the image. It is normally compensated for by the automatic gain control. In some lighting conditions, you may need to manually adjust the red and blue settings for optimal viewing. When Automatic White Balance is enabled, the camera measures the image and automatically adjusts the red and blue settings to balance white. When Automatic White Balance is disabled, the camera uses the values set for the red and blue settings to balance white.
 - **Mode:**
 - * **Auto:** Computes the white balance value output using color information from the entire screen automatically.
 - * **Manual:** Manual mode, you can change R and B Gain manually.
 - **R Gain:** The R gain can be adjusted in the range 0 ~ 255. This is only available if exposure mode is set to Manual.
 - **B Gain:** The B gain can be adjusted in the range 0 ~ 255. This is only available if exposure mode is set to Manual.

4) Day & Night

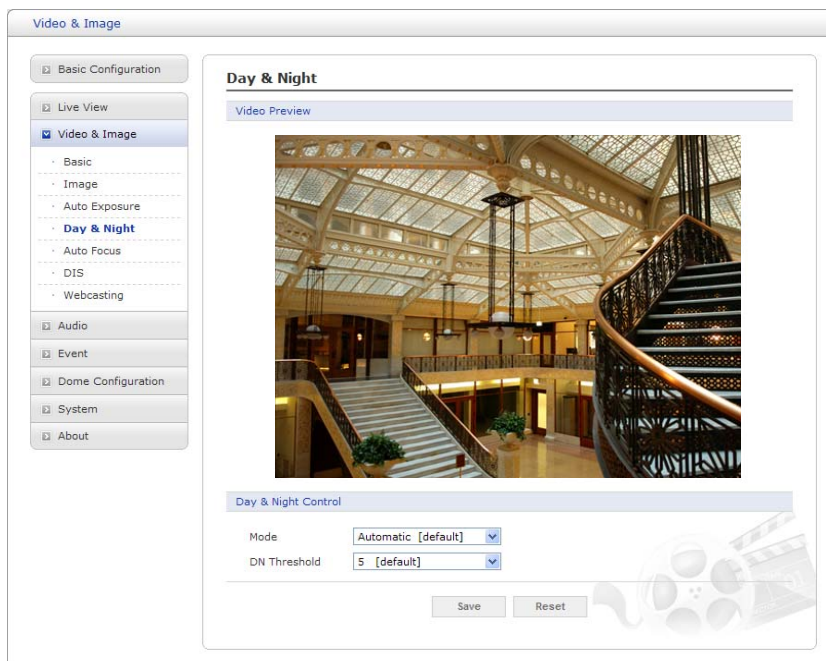

- **Day & Night Control:** Select the day & night mode from among three modes.
 - **Mode:**
 - * **Automatic:** Normally displays color image, and switches automatically to black & white image after the ambient light level reaches a pre-defined threshold.

- * **Day:** Always displays color image.
- * **Night:** Always displays black & white image.
- **DN Threshold:** Adjusts the level of light which the camera automatically switches between color and black & white image. (0 ~ 10)

5) Auto Focus

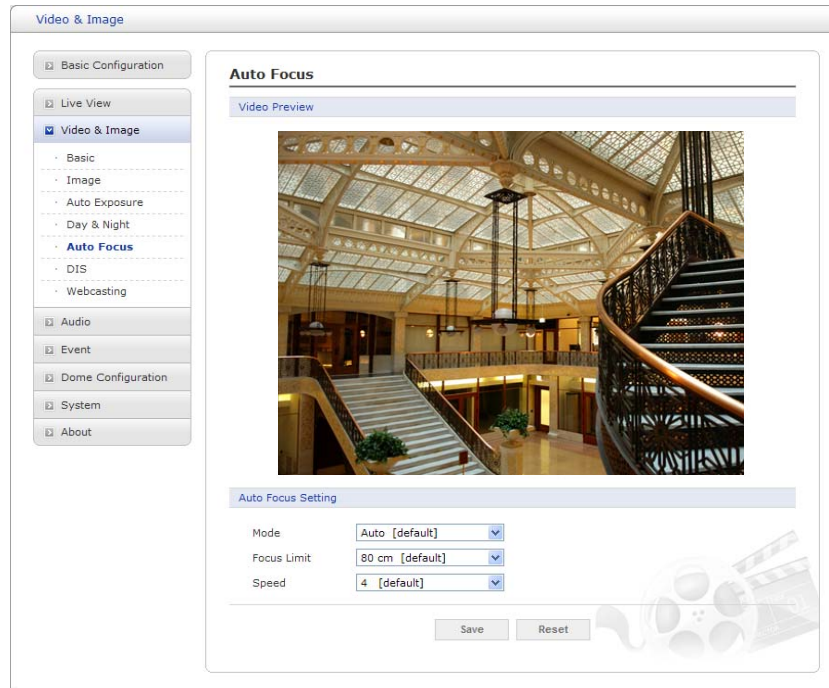

- **Auto Focus Setting:** Continuously adjusts the lens automatically to the correct focus for the sharpest picture.
 - **Mode:**
 - * **Auto:** Auto Focus is always active.
 - * **Manual:** Auto Focus is inactive.
 - **Focus limit:** This distance is approximate value, and the focus operates from the setting value.
 - **Speed:** The speed can be adjusted in the range 1 ~ 8.
- NOTE:** Avoid continuous, 24-hour use of the auto focus. This will shorten the lifespan of the lens.

6) DIS

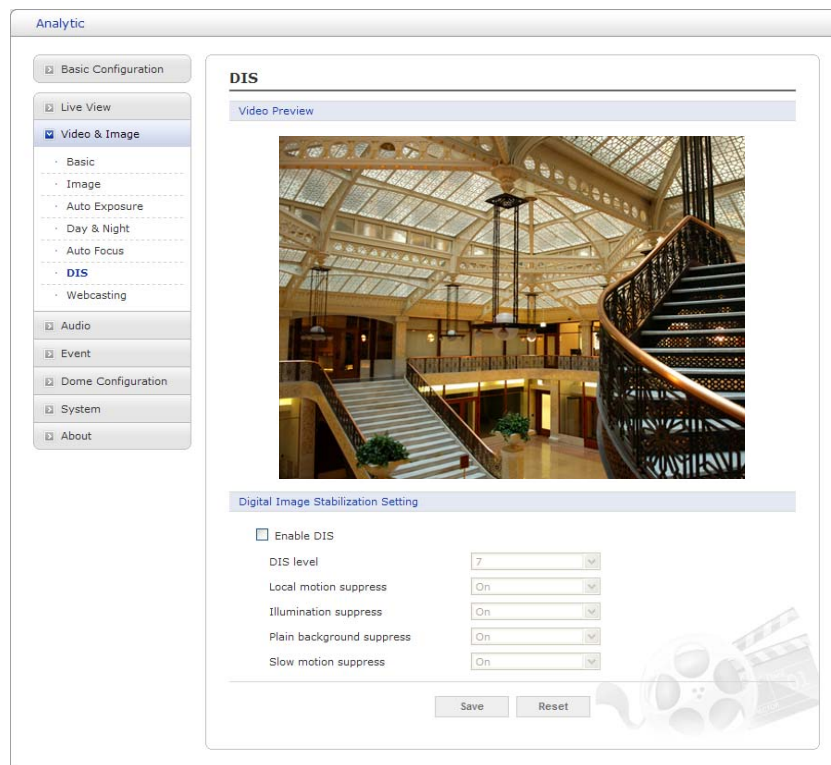

- **Digital Image Stabilization Setting:** Controls DIS level from 0 to 9 and usage of 4 suppress: Local motion, Illumination, Plain background, and Slow motion.

7) Webcasting

The network camera can stream live video to a website. Copies the HTML code generated on the screen and pastes it in page code of the website you want to display live video.

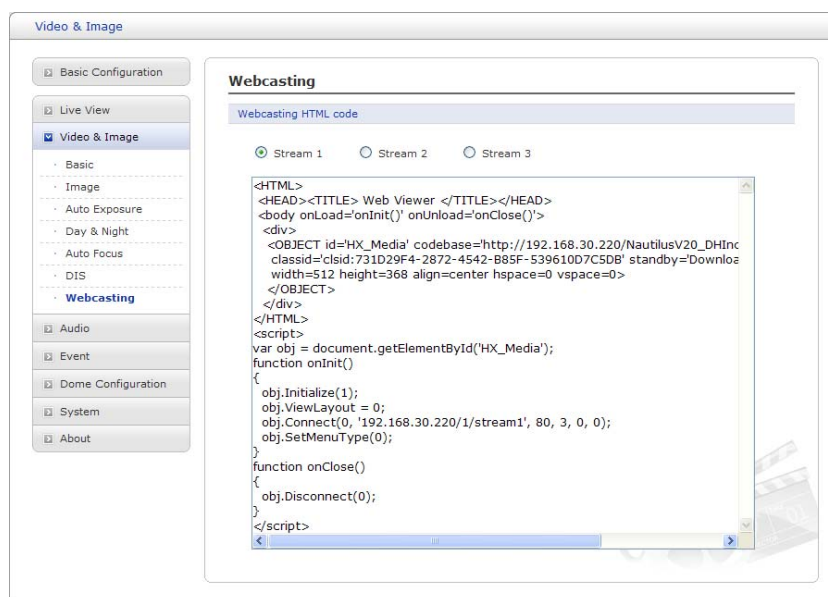

NOTE: To use webcasting service, the Enable Anonymous viewer login option must be checked. Refer to “3.5.1 Basic Configuration > Users” for more details.

3.5.4 Audio

Audio

- Basic Configuration
- Live View
- Video & Image
- Audio**
 - Basic**
 - Event
 - Dome Configuration
 - System
 - About

Audio - Basic

Audio Setting

Enable audio

- Compression type: G.711 u-law
- Sample rate: 8KHz
- Sound bitrate: 64kbps

Audio Input

Input: Internal Amp

Input volume: 0 [dB] Mute

Audio Output

Enable full duplex

- Output volume: 0 [dB] Mute

Save Reset

Refer to “3.5.1 Basic Configuration > Audio” for more details.

3.5.5 Event

1) Event In

▼ On Boot

Event

- Basic Configuration
- Live View
- Video & Image
- Audio
- Event**
 - Event In**
 - On Boot**
 - Alarm In
 - Manual Trigger
 - Motion
 - Network Loss
 - Tampering
 - Event Out
 - Event Map
- Dome Configuration
- System
- About

Event In - On Boot

On Boot Setting

Enable on boot

- Dwell time: 3 [1... 180] sec

Save Reset

This is used to trigger the event every time the network camera is started. Select “Enable” to activate the motion event.

▼ Alarm In

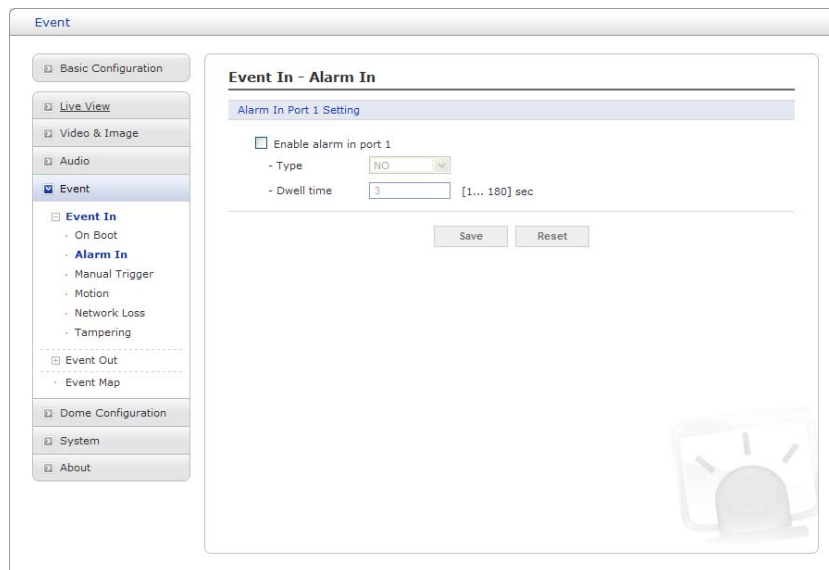

This page allows you to configure the input supported by the camera. The Port can be given as Normally Open or Normally Close state, and their Normal state can be configured.

An input will be inactive as long as its Normal state equals its Current state. The 2 options for Normal state are NO (Normally Open) and NC (Normally Close). The input is activated when the Current state changes so that it no longer equals the Normal state.

● Alarm In Port 1 Setting:

Click the Enable alarm in port 1 checkbox to enable the Alarm In port 1.

- **Type:** The default setting is NO.

* **NO:** Normally Open

As an example, if the Normal state for a push button connected to an input is Open circuit, this means that as long as the button is not pushed (and the Current state remains as Open circuit), the state will be inactive.

* **NC:** Normally Close

When the button is pushed, the circuit is grounded, the input's state changes to Grounded circuit and the input will no longer be in its normal state - it will have become active.

An input on the camera has an Open circuit when disconnected or when there is a voltage.

- **Dwell time:** The default setting is 60 seconds. Dwell time means how long time the alarm input signal hold on as an input signaling source.

Click the **Save** button to save the settings, or click the **Reset** button to clear all of the information you entered without saving it.

▼ Manual Trigger

Event

- Basic Configuration
- Live View
- Video & Image
- Audio
- Event
 - Event In
 - On Boot
 - Alarm In
 - Manual Trigger**
 - Motion
 - Network Loss
 - Tampering
 - Event Out
 - Event Map
- Dome Configuration
- System
- About

Event In - Manual Trigger

Manual Trigger 1 Setting

Enable manual trigger 1
- Dwell time [1... 180] sec

Manual Trigger 2 Setting

Enable manual trigger 2
- Dwell time [1... 180] sec

Manual Trigger 3 Setting

Enable manual trigger 3
- Dwell time [1... 180] sec

Manual Trigger 4 Setting

Enable manual trigger 4
- Dwell time [1... 180] sec

Save Reset

This option makes use of the **Manual Trigger** button provided on the Live View page, which is used to start or stop the event type manually. Alternatively, the event can be triggered via the product's API (Application Programming Interface).

▼ Motion

Event

- Basic Configuration
- Live View
- Video & Image
- Audio
- Event
 - Event In
 - On Boot
 - Alarm In
 - Manual Trigger
 - Motion**
 - Network Loss
 - Tampering
 - Event Out
 - Event Map
- Dome Configuration
- System
- About

Event In - Motion

Video Preview

Video Motion Detection Setting

Enable video motion detection
- Sensitivity [1... 100]

ID	Name	Type	Threshold	Dwell	Delete
1	Motion 1	Include	2	3	X
2	Motion 2	Include	2	3	X

Save Reset

Motion detection is used to generate an alarm whenever movement occurs (or stops) in the video image. A total of 8 Motion and/or Mask windows can be created and configured.

Motion is detected in defined **Motion** windows, which are placed in the video image to target specific areas. Movement in the areas outside the motion windows will be ignored. If part of a motion window needs to be masked, this can be configured in a **Mask** window.

- **Pre-Viewer:** Motion detection windows are configured by Motion or Mask windows. Each window can be selected by clicking with the mouse. It is also possible to **resize, delete** or **move** the window, by selecting the appropriate window at the mouse menu on the video screen.



To create a motion or mask window, follow these steps:

1. Click the right button of mouse to see the mouse menu.
2. Select New Motion (or New Mask) from the mouse menu.
3. Click and drag mouse to designate a motion area.

- **Motion Detection Setting:** The behavior for each window is defined by adjusting the Threshold and Sensitivity, as described below.

A motion index is a set of parameters describing Window Name, Type, Threshold and Dwell Time. Window Types is one of Motion and Mask windows.

- **Threshold:** Sets up the threshold for the motion detection.

- **Dwell Time:** Sets the hold time an event lasts for the specified hold time from the point of detection of a motion.

You can also modify or delete a motion index. Select an index and then, click the **Modify** or **Delete** button.

Select “Enable” to activate the motion window.

▼ Network Loss

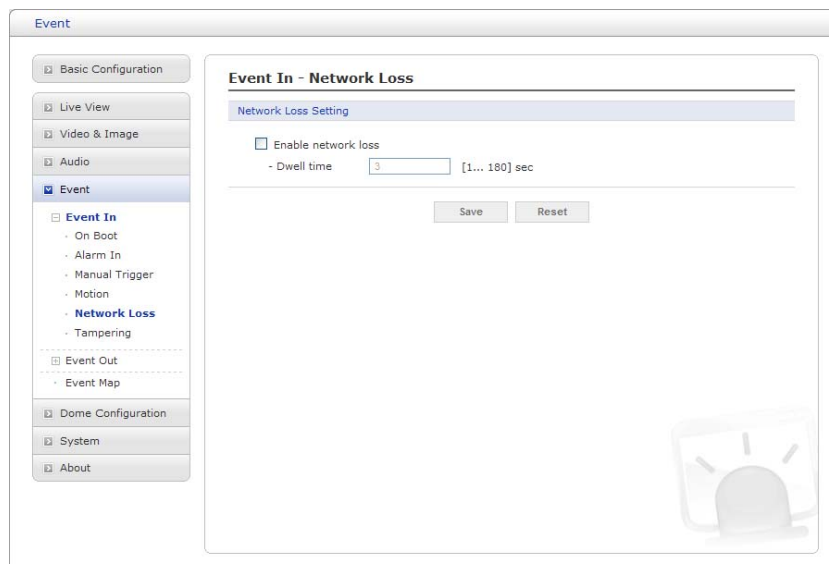

This is used to trigger the event every time the network connection fails. Select “Enable” to activate the Network Loss event.

▼ Tampering

Event

Basic Configuration

Live View

Video & Image

Audio

Event

- Event In
 - On Boot
 - Alarm In
 - Manual Trigger
 - Motion
 - Network Loss
 - Tampering**
- Event Out
 - Event Map

Dome Configuration

System

About

Event In - Tampering

Tampering Setting

Enable tampering

- Dwell time [1... 180] sec

Save Reset

This is used to trigger the event when camera tampering occurs. Select “Enable” to activate the Tampering event.

2) Event Out

▼ SMTP (E-Mail)

Event

Basic Configuration

Live View

Video & Image

Audio

Event

- Event In
- Event Out**
 - SMTP(E-Mail)**
 - FTP & JPEG
 - HTTP Server
 - Alarm Out
 - Audio Alert
 - PTZ Preset
 - Event Notification
 - Boost
 - Event Map

Dome Configuration

System

About

Event Out - SMTP(E-Mail)

SMTP(E-Mail) Setting

Enable SMTP

- Sender

- Interval [1... 86400] sec

- Aggregate events [1... 100]

Use mail server

- Mail server

- Port

- Connections security

Enable use(SMTP) authentication

- User name

- Password

- Login method

SMTP(E-Mail) Receiver

Receiver 1 Receiver 2

Receiver 3 Receiver 4

Receiver 5 Receiver 6

Receiver 7 Receiver 8

SMTP(E-Mail) Test

Receiver Test

Save Reset

The network camera can be configured to send event and error email messages via SMTP (Simple Mail Transfer Protocol).

- **SMTP (E-Mail) Setting:** Select “Enable” to activate the SMTP operation.

- **Mail Server/Port:** Enter the host names (or IP addresses) and port numbers for your mail server in the fields provided to enable the sending of notifications and image email messages from the network camera to predefined addresses via SMTP.
 - **Sender:** Enter the email address to be used as the sender for all messages sent by the network camera.
 - **Interval:** Represents the frequency of the email notification when an event occurs.
 - **Aggregate events:** Shows the maximum number of emails sent within each interval.
- If your mail server requires authentication, check the box for use (SMTP) authentication to log in to this server and enter the necessary information.
- **User name/Password:** Enter the User name and Password as provided by your network administrator or ISP (Internet Service Provider).

To ensure that the login procedure is performed as securely as possible when using SMTP authentication, you must define the weakest authentication method allowed.

- **Login method:** Set the Weakest method allowed to the highest/safest method supported by the mail server. The most secure method is listed in the drop-down list:
* **AUTH LOGIN/AUTH PLAIN**

- **SMTP (E-Mail) Receiver:**

- **Receiver:** Enter an email address. You can also register the e-mail address of up to 8 recipients.

- **SMTP (E-Mail) Test:**

- **Receiver:** Enter an email address and click the **Test** button to test that the mail servers are functioning and that the email address is valid.

▼ FTP & JPEG

When the network camera detects an event, it can record and save images to an FTP server. Images can be sent as e-mail attachments. Check the box to enable the service.

- **FTP Setting:**

- **Server:** Enter the server's IP address or host name.

NOTE: A DNS server must be specified in the TCP/IP network settings if using a host name.

- **Port:** Enter the port number used by the FTP server. The default is 21.
- **Use passive mode:** Under normal circumstances the network camera simply requests the target FTP server to open the data connection. Checking this box issues a PASV command to the FTP server and establishes a passive FTP connection, whereby the network camera actively initiates both the FTP control and data connections to the target server. This is normally desirable if there is a firewall between the camera and the target FTP server.
- **Remote directory:** Specify the path to the directory where the uploaded images will be stored. If this directory does not already exist on the FTP server, there will be an error message when uploading.
- **User name/Password:** Provide your log-in information.

● **JPEG Setting:**

- **Pre-event:** A pre-event buffer contains images from the time immediately preceding the event trigger. These are stored internally in the server. This buffer can be very useful when checking to see what happened to cause the event trigger.

Check the box to enable the pre-trigger buffer, enter the desired total length in seconds, minutes or hours, and specify the required image frequency.

- **Post-event:** This function is the counterpart to the pre-trigger buffer described above and contains images from the time immediately after the trigger. Configure as for pre-event.
- **Prefix file name:** This name will be used for all the image files saved. If suffixes are also used, the file name will take the form <prefix>, <suffix>, <extension>.
- **Additional suffix:** Add either a date/time suffix or a sequence number - with or without a maximum value.

▼ **HTTP Server**

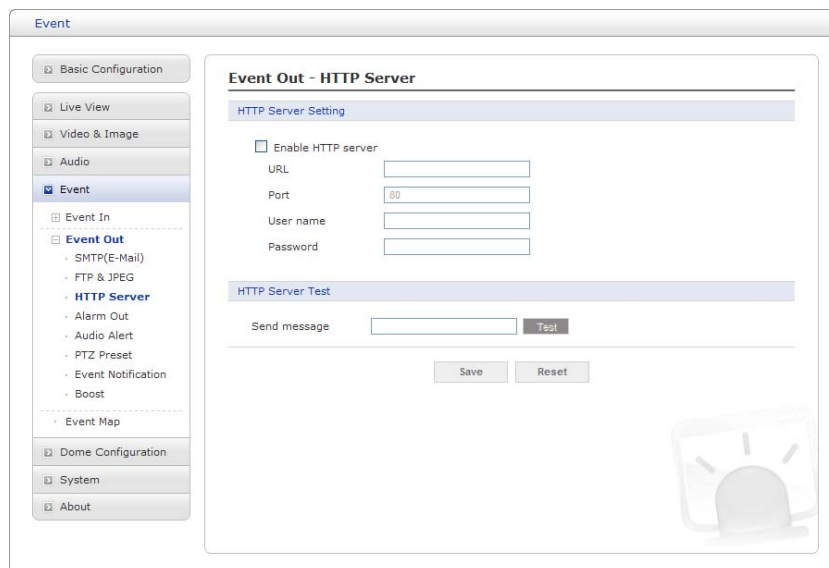

When the network camera detects an event, the HTTP Server is used to receive uploaded image files and/or notification messages. Check the box to enable the service.

- **HTTP Server Setting:**

- **Name:** The name of the HTTP event server. Use a descriptive name.
- **URL:** The network address to the server and the script that will handle the request.

For example: <http://192.168.12.244/cgi-bin/upload.cgi>

- **User name/Password:** Provide your log-in information.

- **HTTP Server Test:** When the setup is complete, the connection can be tested by clicking the **Test** button.

▼ Alarm Out

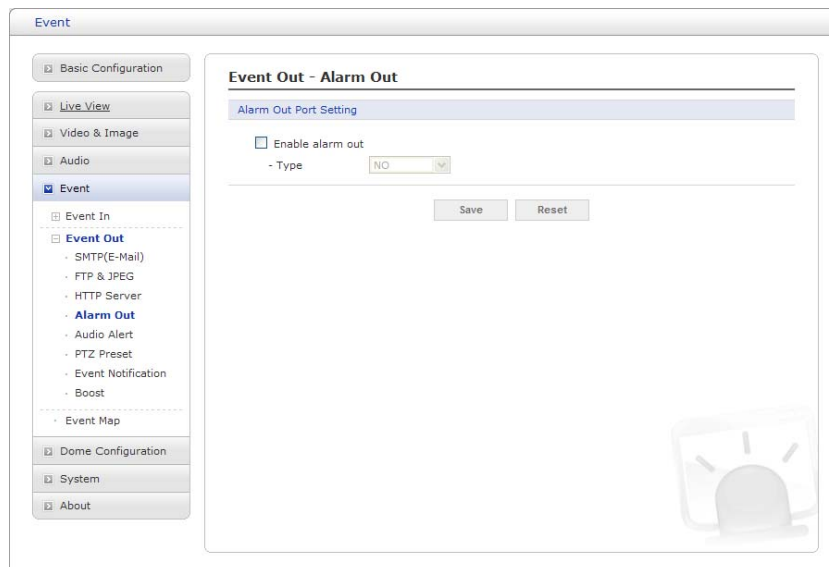

- **Enable alarm out:** Click the Enable alarm out checkbox to enable the Alarm Out port.

- **Type:** The default setting is NO.

- * **NO:** Normally Open

- * **NC:** Normally Close

Click the **Save** button to save the settings, or click the **Reset** button to clear all of the information you entered without saving it.

▼ Audio Alert

Event

Basic Configuration

Live View

Video & Image

Audio

Event

Event In

Event Out

- SMTP(E-Mail)
- FTP & JPEG
- HTTP Server
- Alarm Out
- **Audio Alert**
- PTZ Preset
- Event Notification
- Boost

Event Map

Dome Configuration

System

About

Event Out - Audio Alert

Audio Alert Setting

Enable audio alert

- Audio file 1

- Audio file 2

- Audio file 3

Audio Alert Test

No.	File Name	File Size	Play Time	Bitrate
-----	-----------	-----------	-----------	---------

* Note
Total file size must be less than 512KB.

When the network camera detects an event, it can output predefined audio data to an external speaker. Check the box to enable the service.

- **Audio Alert Setting:** To use the Audio Alert with the network camera, an audio data file made by the user must be uploaded from your PC. Provide the path to the file directly, or use the **Browse** button to locate it. Then click the **Upload** button.

An audio file for Audio Alert can be made by Audio Recorder tool in the NCTitanium software.

- **Audio Alert Test:** When the setup is complete, the audio output can be tested by clicking the **Test** button.

To remove an audio file, select index and click the **Remove** button.

NOTE: For the proper operation of Audio Alert, you must enable “full duplex” on the Audio setting page.

▼ PTZ Preset

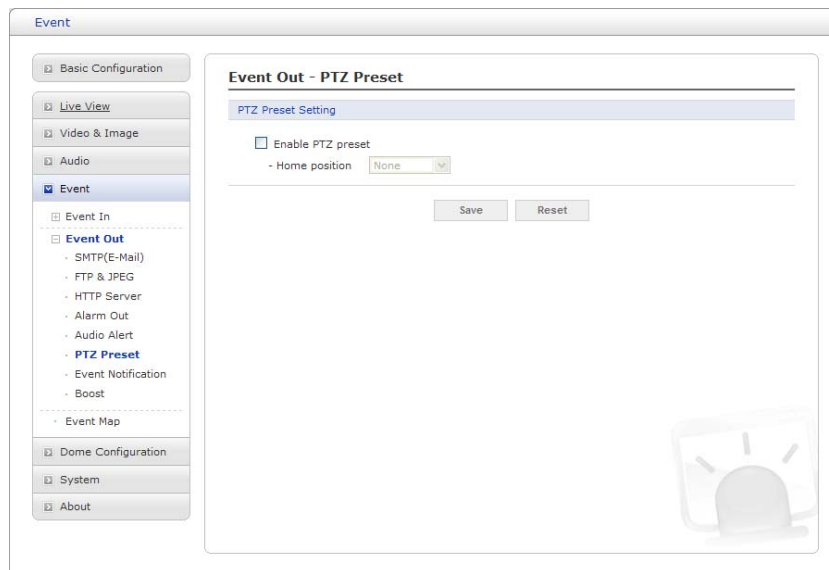

The screenshot shows a web interface for configuring PTZ Presets. On the left is a navigation menu with categories: Basic Configuration, Live View, Video & Image, Audio, Event, Dome Configuration, System, and About. The 'Event' category is expanded, showing sub-items: Event In, Event Out (selected), SMTP(E-Mail), FTP & JPEG, HTTP Server, Alarm Out, Audio Alert, PTZ Preset, Event Notification, Boost, and Event Map. The main content area is titled 'Event Out - PTZ Preset' and contains a 'PTZ Preset Setting' section. It features a checkbox for 'Enable PTZ preset' which is currently unchecked. Below it is a 'Home position' dropdown menu set to 'None'. At the bottom of the settings are 'Save' and 'Reset' buttons. A small camera icon is visible in the bottom right corner of the main content area.

When the camera detects an event, you can move the camera to a predefined preset position. Check the box to enable the service and return to the Home position once the event has ended.

▼ Event Notification

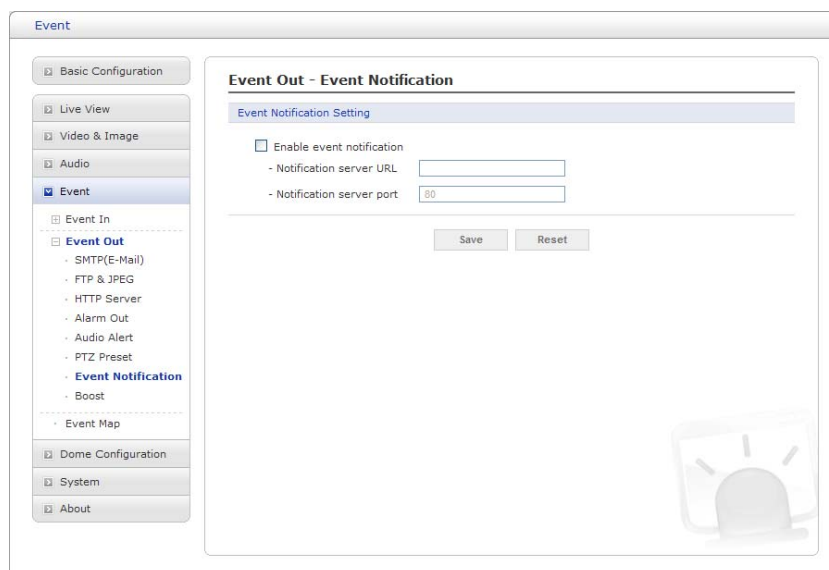

The screenshot shows a web interface for configuring Event Notification. The navigation menu is identical to the previous screenshot, with 'Event Notification' selected under the 'Event' category. The main content area is titled 'Event Out - Event Notification' and contains an 'Event Notification Setting' section. It features a checkbox for 'Enable event notification' which is currently unchecked. Below it are two input fields: 'Notification server URL' and 'Notification server port' (set to '80'). At the bottom of the settings are 'Save' and 'Reset' buttons. A small camera icon is visible in the bottom right corner of the main content area.

When the network camera detects an event, Notification server is used to receive notification messages as a type of XML data format. Check the box to enable the service.

• Event Notification Setting:

- **Notification Server URL:** The network address to the server and the script that will handle the request.

▼ Boost

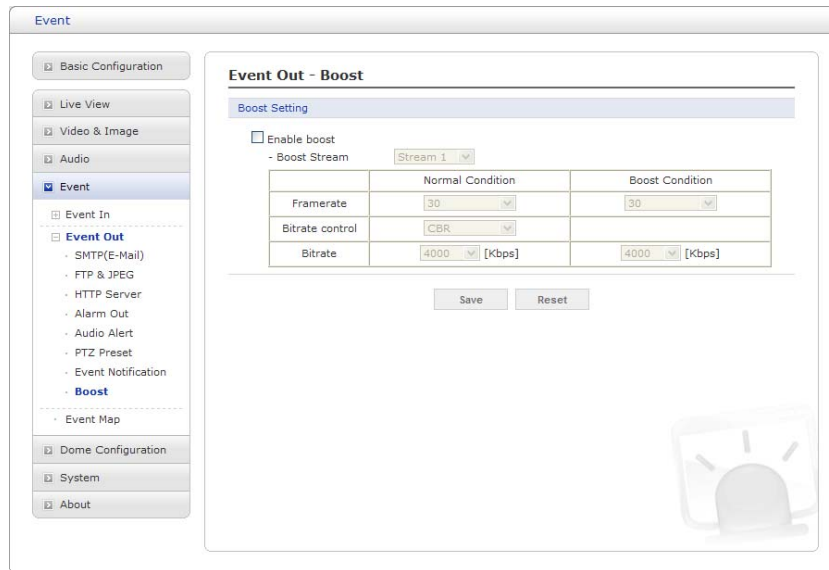

The Boost feature is used in conjunction with event detection. When this feature is turned ON, the Frame rate and Bit rate in the boost condition can be set to a different value than the ones in the normal condition field. When an event is detected, the camera will boost the Frame rate and Bit rate from the normal condition to this boosted level for the duration of the event.

Check the box to enable the service.

- **Boost Setting:** You can set the condition in Normal and Boost mode.
 - **Boost Stream:** Select a video stream for each condition in the drop-down list.
 - **Frame rate:** Select a frame refresh rate per second for each condition in the drop-down list.
 - **Bit rate control:** Select VBR or CBR in the drop-down list in Normal Condition. You can't change it in Boost Condition.
 - **Bit rate:** Select a value for each condition in the drop-down list.

3) Event Map

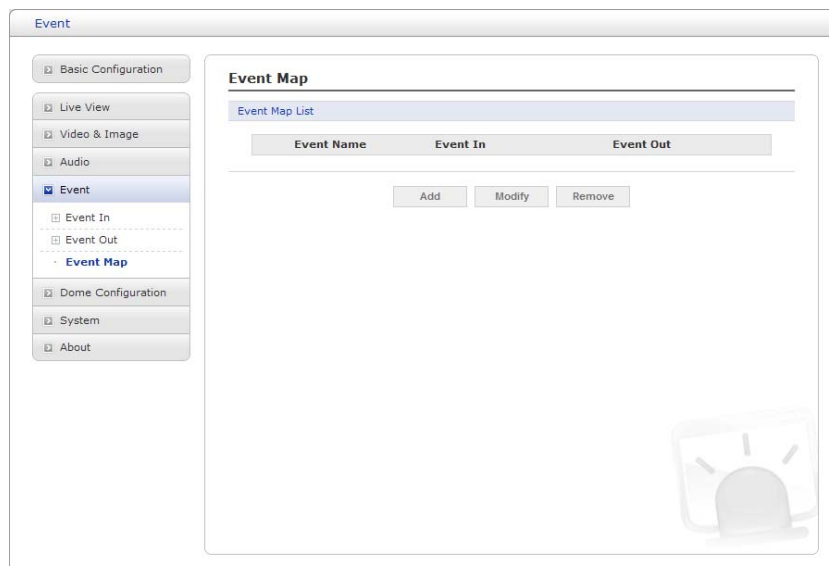

The event map allows you to change the settings and establish a schedule for each event trigger from the network camera. You can register the event map up to max. 15.

Click the **Add** button to make a new event map: a popup window display as below.

- **General:** Enter the name for a new event map.
- **Event In:** Select an event type in the drop-down list.
- **Event Out:**
 - **E-mail:** Select the email addresses you want to notify via email that an event has occurred.
 - **FTP:** Select checkbox beside FTP to record and save images to an FTP server when an event has occurred.
 - **HTTP Server:** It sends notification messages to an HTTP server that listens for these. The destination server must first be configured on the Event In page. Enter a message you want to send.
 - **Audio Alert:** Select an Audio Alert file as the Network Transmitter output when audio alert event triggered. The Audio Alert file must first be configured on the Event In page.
 - **Event Notification:** It sends XML messages to an Notification server that listens for these. The destination server must first be configured on the Event In page.
 - **Boost:** when an event has occurred, the camera will boost the Frame rate and Bit rate from the normal condition to this boosted level for the duration of the event. Check the box to enable the Function.

3.5.6 Dome Configuration

1) Preset

If you need to view specific places routinely, you should program Presets. A Preset is a programmed video scene with automatic pan, tilt, zoom and focus settings.

Once programmed, clicking the Preset number or clicking the Go button in the PTZ Control Panel calls up that Preset automatically.

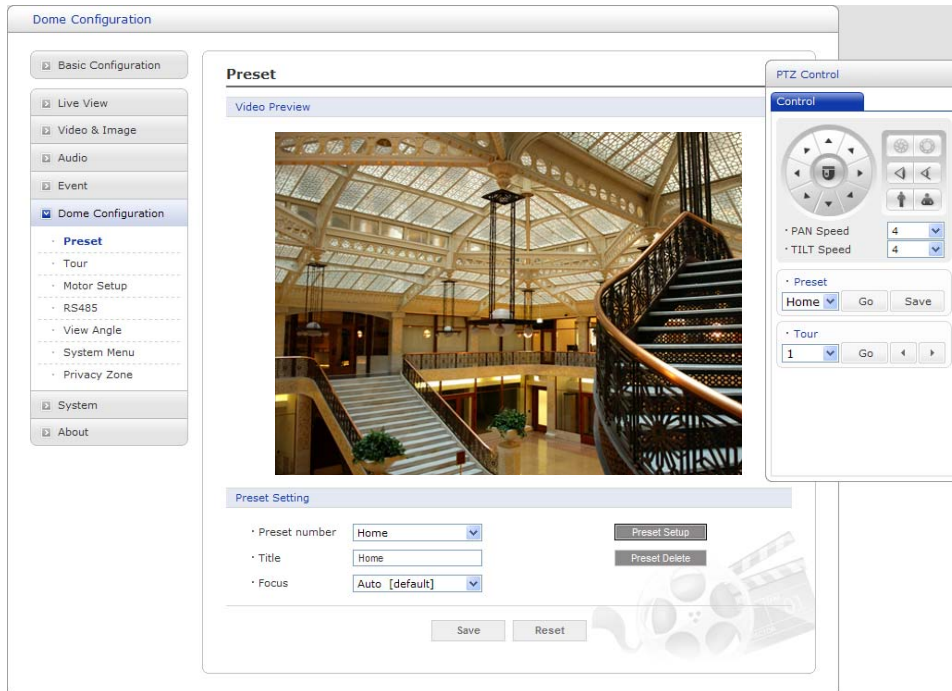

• Preset Setting:

- **Preset number:** The Preset number can be selected in the range 1 – 240 or Home.
- **Title:** Up to 12 characters (Alphanumeric characters and space)
- **Focus:**
 - * **Auto:** Auto Focus is always active.
 - * **Manual:** Auto Focus is inactive.
- **Preset Setup:** Activate the PTZ Control Panel.
- **Preset Delete:** Delete selected Preset number.

Follow steps below to store the Preset positions:

1. Click the **Preset Setup** button, then shows the PTZ Control Panel.
2. Choose the desired Preset number from the Preset drop-down list:
3. After aiming the camera (view direction and lens control) by using the **Arrow** and **Zoom** button in PTZ Control Panel, click the **Save** button.
4. Repeat step 2 through 3 for each additional Preset position.

2) Tour

There are 8 programmable Tours. Each Tour consists of up to 100 Presets.

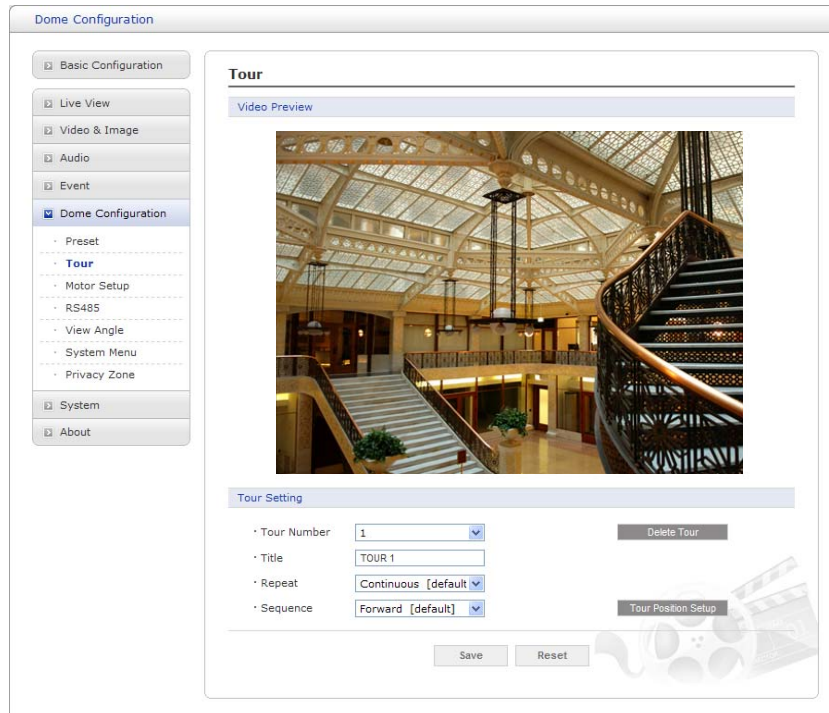

• Tour Setting:

- **Tour Number:** The Tour number can be selected in the range 1 - 8.
- **Title:** Up to 12 characters (Alphanumeric characters and space)
- **Repeat:** Select number of repetition from Continuous to 90. The default is Continuous.
- **Sequence:** Select either forward or backward sequence in the Tour position list.
- **Delete Tour:** Delete the stored Tour Position Setup list of Tour number.
- **Tour Position Setup:** Open or close the Tour Position Setup as below.

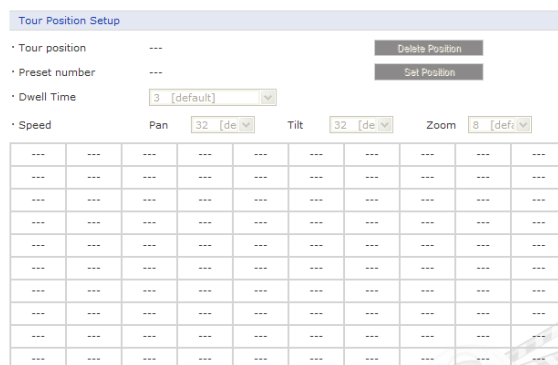

• Tour Position Setup:

- **Tour position:** The Tour position can be selected in the range 1 ~ 100.
- **Preset number:** Show the selected Preset number.
- **Dwell Time:** Select the Dwell Time from 0 to 99 seconds. The default is 3 seconds.
- **Speed:** Adjust Pan/Tilt/Zoom Speed if you want to a slow movement. The defaults are maximum Speed.

- **Delete Position:** If you want to remove Tour position from Tour Position Setup list, select the desired Tour Position, and click the **Delete Position** button.
- **Set Position:** Click the **Set Position** button, then show the stored Presets or Home on drop-down list.

Follow steps below to program the Tours:

1. Click the desired Tour position of Tour Position Setup list, and click **Set Position** button, then show the saved Presets or Home on drop-down list. Click a Preset or Home.
2. Repeat step 1 for each desired position.
3. Click the **Save** button to save the settings, or click the **Reset** button to clear all of the information you entered without saving it.

3) Motor Setup

Motor Setup menu provides the pan and tilt speed of a camera.

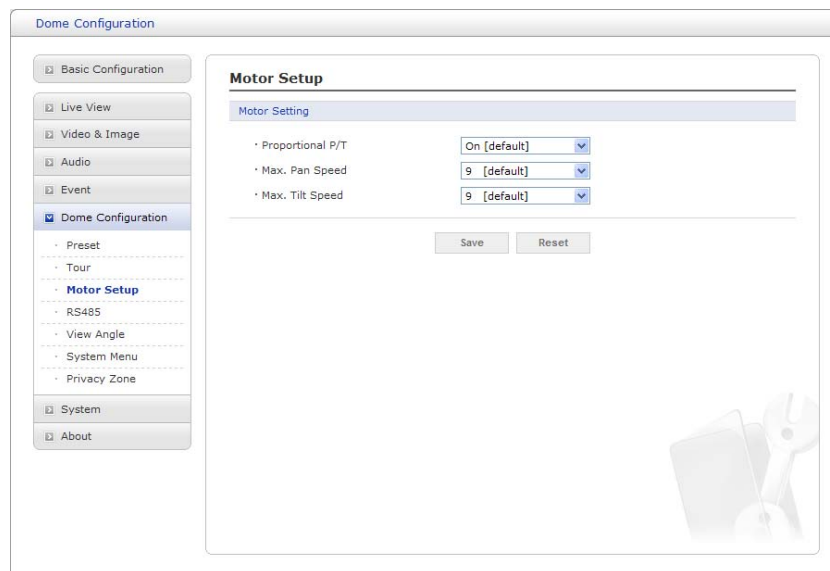

- **Motor Setting:**

- **Proportional P/T:** Select On or Off.
- **Max. Pan Speed:** The maximum pan speed can be adjusted in the range 1 ~ 38.
- **Max. Tilt Speed:** The maximum tilt speed can be adjusted in the range 1 ~ 30.

4) RS485

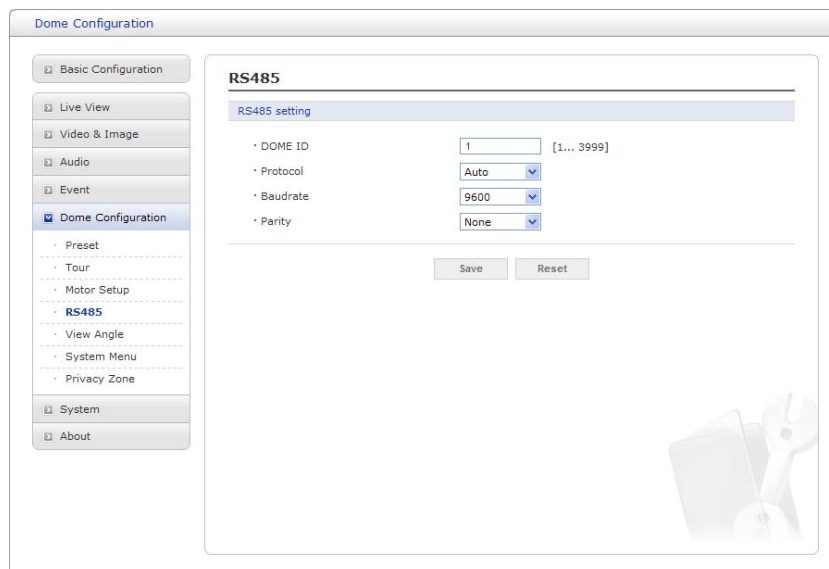

Dome Configuration

Basic Configuration

Live View

Video & Image

Audio

Event

Dome Configuration

- Preset
- Tour
- Motor Setup
- RS485**
- View Angle
- System Menu
- Privacy Zone

System

About

RS485

RS485 setting

- DOME ID: [1... 3999]
- Protocol:
- Baudrate:
- Parity:

• RS485 Setting:

- **DOME ID:** Enter identification number for external PTZ device. The DOME ID can be adjusted in the range 1 ~ 3999.
- **Protocol:** Selects PTZ protocol to communicate with external PTZ device.
- **Baud rate:** Selects one of the Baud rate.
- **Parity:** Selects one of the Parity bit.

5) View Angle

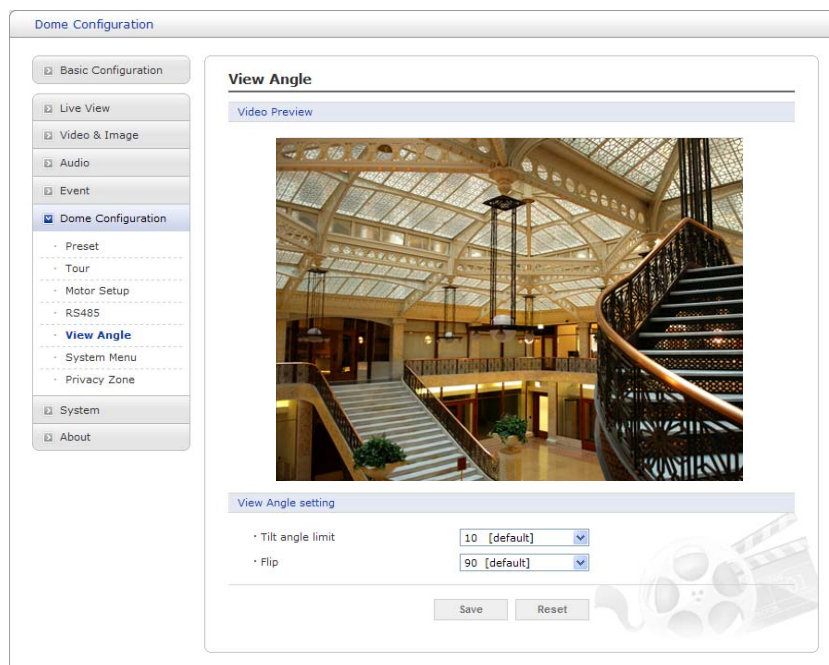

Dome Configuration

Basic Configuration

Live View

Video & Image

Audio

Event

Dome Configuration

- Preset
- Tour
- Motor Setup
- RS485
- View Angle**
- System Menu
- Privacy Zone

System

About

View Angle

Video Preview



View Angle setting

- Tilt angle limit:
- Flip:

• View Angle Setting:

- **Tilt angle limit:** This option is designed to limit the view angle as there is some obstruction in zooming out on specific areas of the tilt angle.
- NOTE:** Focus issues may occur if the tilt angle limit is set below 10 degree.

- Flip:

- * **Off:** The dome camera moves until 90° vertically.
- * **Auto:** When the camera reaches the floor directly above the moving object, it will stop. At that time, release the Joystick instantly and pull it down again to run the auto-flip function. When you use the panning range, it is recommended to use the flip mode to Auto.
- * **90, 100, 110, 120:** Allows the image to flip digitally when the camera moves over the setting angle vertically.

6) System Menu

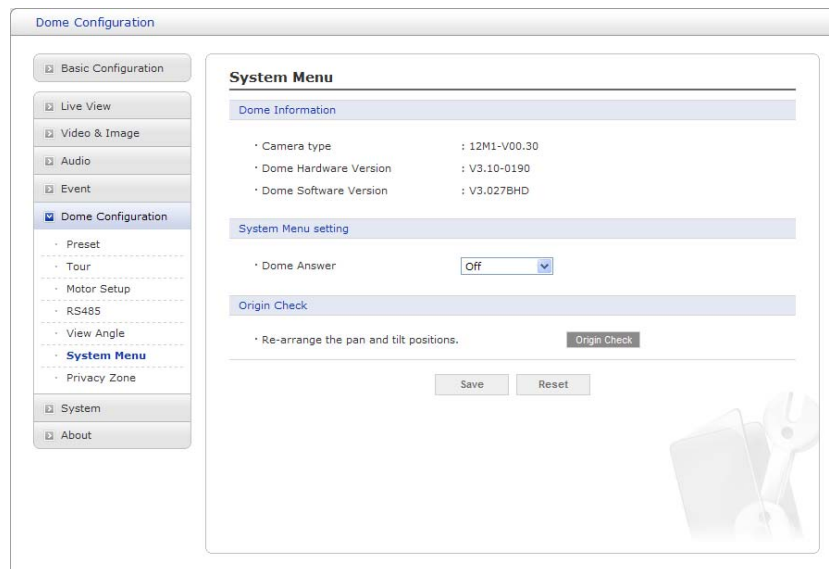

- **Dome Information:** The system information provides essential information about the dome if service is required. The information cannot be modified.
- **System Menu setting:**
 - **Dome Answer:** Select On or Off for acknowledge command from the dome. This option is helpful to escape the collision of the command using some DVR.
- **Origin Check:** If you find the dome in the wrong position during operation, execute this origin check by clicking **Origin Check** button and the dome camera will return to the right position after the origin check operation.

7) Privacy Zone

Using privacy zones (masks), you can hide up to 8 unwanted scenes in a camera. The color of privacy zones is gray.

The screenshot shows the 'Dome Configuration' web interface. On the left is a navigation menu with options like 'Basic Configuration', 'Live View', 'Video & Image', 'Audio', 'Event', 'Dome Configuration', 'System', and 'About'. The 'Dome Configuration' menu is expanded to show sub-options: 'Preset', 'Tour', 'Motor Setup', 'RS485', 'View Angle', 'System Menu', and 'Privacy Zone'. The 'Privacy Zone' option is selected. The main content area is titled 'Privacy Zone' and contains a 'Video Preview' window showing a dark gray area. To the right is a 'PTZ Control' panel with a directional pad, 'PAN Speed' and 'TILT Speed' sliders, and buttons for 'Home', 'Go', 'Save', and 'Tour'. Below the video preview is a 'Privacy Zone setting' table.

No.	Title	V.off	Set	Delete
1	MASK-1	On	Set	X
2	MASK-2	Off	Set	X
3	MASK-3	Off	Set	X
4	MASK-4	Off	Set	X
5	MASK-5	Off	Set	X
6	MASK-6	Off	Set	X
7	MASK-7	Off	Set	X
8	MASK-8	Off	Set	X

- **Privacy Zone Setting:** Following steps below to configure the privacy zones;
 1. After aiming the camera (view direction and lens control) by using the **Arrow** and **Zoom** button in PTZ Control Panel, click **Set** cell of Set column at any inactive row to create privacy zone.
 2. You can change the Title up to 12 alphanumeric characters.
 3. In order to hide or display the privacy zone, choose On or Off in V.off column.
 4. Click X at Delete column to delete privacy zone.

3.5.7 System

1) Information

You can enter the system information. This page is very useful when you require device information after installation.

System

Basic Configuration

Live View

Video & Image

Audio

Event

Dome Configuration

System

Information

Security

Date & Time

Network

Language

Maintenance

Support

About

Information

Device Name Configuration

Device name: H.264 Network Camera

Location Configuration

Location1: []

Location2: []

Location3: []

Location4: []

Save Reset

- **Device Name Configuration:** Enter the device name.
- **Location Configuration:** Enter the location information. You can enter up to four locations.

2) Security

▼ Users

System

Basic Configuration

Live View

Video & Image

Audio

Event

Dome Configuration

System

Information

Security

Users

HTTPS

IP Filtering

Date & Time

Network

Language

Maintenance

Support

About

Security - Users

User Setting

Enable anonymous viewer login

User List Setting

User Name	User Group	Authority
admin	administrator	live, setup, system, ptz

Add Modify Remove

Save Reset

User access control is enabled by default when the administrator sets the root password on first access. New users are authorized with user names and passwords, or the administrator can choose to allow anonymous viewer login to the Live View page, as described below:

- **User Setting:** Check the box to enable anonymous viewer login to the network camera without a user account. When using the user account, users have to log-in at every access.

- **User List Setting:** This section shows how to register a user account. Enter a user name and password to be added, and register them by pressing the **Add** button. You will see the pop-up window as below.

▼ HTTPS

For greater security, the network camera can be configured to use HTTPS (Hypertext Transfer Protocol over SSL (Secure Socket Layer)). Then all communication that would otherwise go via HTTP will instead go via an encrypted HTTPS connection.

- **HTTPS Connection Policy:** Choose the form of connection you wish to use from the drop-down list for the administrator, Operator and Viewer to enable HTTPS connection (set to HTTP by default).

- HTTP

- HTTPS

- HTTP & HTTPS

- **Upload Certificate:** To use HTTPS for communication with the network camera, an official certificate issued by a CA (Certificate Authority) must be uploaded from your PC. Provide the path to the certificate directly, or use the **Browse** button to locate it. Then click the **Upload** button.

Please refer to the home page of your preferred CA for information on where to send the request. For more information, please see the online help.

▼ IP Filtering

The screenshot shows the 'System' configuration page with the 'Security - IP Filtering' section selected. The 'IP Filtering Setting' section includes a checkbox for 'Enable IP filtering' which is currently unchecked. Below this is a table with five rows, each representing a filter rule. Each row has an 'On/Off' checkbox, a 'Priority' field (values 1-5), a 'Policy' dropdown menu (all set to 'ALLOW'), and two IP address fields labeled 'Start IP' and 'End IP', all containing '0.0.0.0'. At the bottom of the table are 'Save' and 'Reset' buttons.

On/Off	Priority	Policy	Start IP	End IP
<input type="checkbox"/>	1	ALLOW	0.0.0.0	0.0.0.0
<input type="checkbox"/>	2	ALLOW	0.0.0.0	0.0.0.0
<input type="checkbox"/>	3	ALLOW	0.0.0.0	0.0.0.0
<input type="checkbox"/>	4	ALLOW	0.0.0.0	0.0.0.0
<input type="checkbox"/>	5	ALLOW	0.0.0.0	0.0.0.0

Checking the **Enable IP address filtering** box enables the IP address filtering function. Up to 256 IP address entries may be specified (a single entry can contain multiple IP addresses). Click the **Add** button to add new filtered addresses.

When the IP address filter is enabled, addresses added to the list are set as allowed or denied addresses. All other IP addresses not in this list will then be allowed or denied access accordingly, that is, if the addresses in the list are allowed, then all others are denied access, and vice versa. Also see the online help for more information.

NOTE: Users from IP addresses that will be allowed must also be registered with the appropriate access rights. This is done from Setup > System > Security > Users.

3) Date & Time

The screenshot shows the 'System' configuration page with the 'Date & Time' section selected. The 'Current Server Time' section displays 'Date : 2013-11-13' and 'Time : 11:32:58'. The 'New Server Time' section includes a 'Time zone' dropdown menu set to '(GMT) Greenwich Mean Time : Dublin, Edinburgh, Lisbon, London' and an unchecked checkbox for 'Automatically adjusts for daylight saving time changes'. The 'Time mode' section has three radio buttons: 'Synchronize with computer time' (selected), 'Synchronize with NTP server', and 'Set manually'. The 'Synchronize with computer time' option shows 'Date : 2013-11-13' and 'Time : 11:34:11'. The 'Synchronize with NTP server' option shows 'NTP server : time.nist.gov' and 'NTP Interval : 12 [hour]'. The 'Set manually' option shows 'Date : 2013-11-13' and 'Time : 11:32:51'. The 'Date & Time Format' section has 'Date Format : YYYY-MM-DD' and 'Time Format : 24 Hour'. At the bottom are 'Save' and 'Reset' buttons.

- **Current Server Time:** This displays the current date and time (24h clock). The time can be displayed in 12h clock format in the overlay (see below).

- **New Server Time:** Select your time zone from the drop-down list. If you want the server clock to automatically adjust for daylight saving time, select “Automatically adjustment for daylight saving time changes”.

From the Time mode section, select the preferred method to use for setting the time:

- **Synchronize with computer time:** Sets the time from the clock on your computer.
- **Synchronize with NTP server:** The network camera will obtain the time from an NTP server every 60 minutes.
- **Set manually:** This option allows you to manually set the time and date.

NOTE: If using a host name for the NTP server, a DNS server must be configured under TCP/IP settings.

4) Network

The screenshot displays the 'Network - Basic' configuration page. On the left is a navigation menu with categories like 'Basic Configuration', 'Live View', 'Video & Image', 'Audio', 'Event', 'Dome Configuration', 'System', 'Information', 'Security', 'Date & Time', 'Network', 'Language', 'Maintenance', 'Support', and 'About'. The 'System' category is expanded, showing sub-items: Information, Security, Date & Time, Network (Basic, DDNS, RTP, uPnP, QoS, NAT, Zeroconf, Bonjour), Language, Maintenance, Support, and About. The main content area is titled 'Network - Basic' and contains several sections: 'IP Address Configuration' (with radio buttons for DHCP and static IP, and input fields for IP address, subnet mask, and default router), 'IPv6 Address Configuration' (with a checkbox for 'Enable IPv6' and an IPv6 address field), 'DNS Configuration' (with radio buttons for DHCP and static DNS server address, and input fields for domain name, primary, and secondary DNS server), 'Host Name Configuration' (with a text input field for the host name), 'Services' (with input fields for HTTP, HTTPS, and RTSP ports), and 'ARP/Ping setting' (with a checked checkbox for 'Enable ARP/Ping setting'). At the bottom right of the main content area are 'Save' and 'Reset' buttons.

Settings in regard to network can be executed. Settings for IP, DNS, Host Name, Port, and ARP/Ping can be established, along with setting for DDNS, uPnP, QoS, Zeroconfig and Bonjour.

▼ Basic

• IP Address Configuration:

- **Obtain IP address via DHCP:** Dynamic Host Configuration Protocol (DHCP) is a protocol that lets network administrators centrally manage and automate the assignment of IP addresses on a network. DHCP is enabled by default. Although a DHCP server is mostly used to set an IP address dynamically, it is also possible to use it to set a static, known IP address for a particular MAC address.

- **Use the following IP address:** To use a static IP address for the network camera, check the radio button and then make the following settings:
 - * **IP address:** Specify a unique IP address for your network camera.
 - * **Subnet mask:** Specify the mask for the subnet the network camera is located on.
 - * **Default router:** Specify the IP address of the default router (gateway) used for connecting devices attached to different networks and network segments.
- **IPv6 Address Configuration:** Check this box to enable IPv6. Other settings for IPv6 are configured in the network router.
- **DNS Configuration:** DNS (Domain Name Service) provides the translation of host names to IP addresses on your network.
 - **Obtain DNS Server via DHCP:** Automatically use the DNS server settings provided by the DHCP server. Click the View button to see the current settings.
 - **Use the following DNS server address** to enter the desired DNS server by specifying the following:
 - * **Domain name:** Enter the domain(s) to search for the host name used by the network camera. Multiple domains can be separated by semicolons (;). The host name is always the first part of a Fully Qualified Domain Name, for example, my server is the host name in the Fully Qualified Domain Name myserver.mycompany.com where mycompany.com is the Domain name.
 - * **DNS servers:** Enter the IP addresses of the primary and secondary DNS servers.
- **Host Name Configuration:**
 - **Host Name:** Enter the host name to be used as device information in the client software or SmartManager.
- **Services:**
 - **HTTP port:**
Enter a port to receive a service through the HTTP. Default Port Number is '80'.
 - **HTTPS port:**
Enter a port to receive a service through the HTTPS. Default Port Number is '443'.
 - **RTSP port:**
Enter a port to receive a service through the RTSP. Default Port Number is '554'.
- **ARP/Ping Setting:**
 - **Enable ARP/Ping setting of IP address:** The IP address can be set using the ARP/Ping method, which associates the unit's MAC address with an IP address. Check this box to enable the service. Leave disabled to prevent unintentional resetting of the IP address.

▼ DDNS

System

Basic Configuration

Live View

Video & Image

Audio

Event

Dome Configuration

System

Information

Security

Date & Time

Network

Basic

DDNS

RTP

UPnP

QoS

NAT

Zeroconf

Bonjour

Language

Maintenance

Support

About

Network - DDNS

Internet DDNS (Dynamic Domain Name Service)

Enable DDNS

Note
Please remember you have to configure at least primary DNS server in DNS configuration settings to use Dynamic DNS.

- DDNS Server: cctv-network.co.kr

- Registered host: [text input]

- User name: [text input]

- Password: [text input]

- Confirm password: [text input]

- Maximum time interval: 1 hour

Register local network IP address

Registered IP address : [text input]

Save Reset

- **Internet DDNS (Dynamic Domain Name Service):** When using the high-speed Internet with the telephone or cable network, users can operate the network camera even on the floating IP environment in which IPs are changed at every access.

Users should receive an account and password by visiting a DDNS service like <http://www.dyndns.com/> or <http://www.cctv-network.co.kr/>.

- **Enable DDNS:** Check to get DDNS service to be available.

* **DDNS Server:** Select the DDNS server.

* **Registered host:** Enter an address of the DDNS server.

* **User name:** Enter an ID to access the DDNS server.

* **Password:** Enter a password to be used for accessing the DDNS server.

* **Confirm password:** Enter the password again to confirm it.

* **Maximum time interval:** Set a time interval to synchronize with the DDNS server. Select an item in the interval drop-down list.

* **Register local network IP address:** Register a Network Video Server IP address to the DDNS server.

▼ RTP

The screenshot shows the 'Network - RTP' configuration page. The sidebar on the left is expanded to 'System', with 'RTP' selected under the 'Network' category. The main content area is titled 'Network - RTP' and contains three sections for configuring RTP streams. Each section has a 'Port Range' section with 'Start port' and 'End port' fields. The 'Multicast' sections have an 'Enable multicast' checkbox, 'Multicast destination IP' field, 'RTP port' field, 'RTP TTL' field, and an 'Enable always multicast' checkbox. The 'Save' and 'Reset' buttons are at the bottom right.

Users can configure settings for sending and receiving audio or video on a real-time basis. These settings are the IP address, port number, and Time-To-Live value to use for the media stream(s) in multicast H.264 format. Only certain IP addresses and port numbers should be used for multicast streams. For more information, please see the online help.

• Port Range:

- **Start port:** Enter a value between 30000 and 39920.
- **End port:** Enter a value between 30000 and 39920.

• Multicast: This function is for sending Video to Multicast group.

- **Enable Multicast:** Check the box to enable multicast operation.
- **Multicast destination IP:** Enter an IP between 224.0.0.0 and 239.255.255.255. Although it is empty, an IP will be entered automatically.
- **RTP port:** Enter a value between 1024 and 65530.
- **RTP TTL:** Enter a value between 1 and 255. If the network status is smooth, enter a lower value. On the other hand, if the network status is poor, enter a higher value. When there are many network cameras or users, a higher value may cause a heavy load to the network. For a detailed explanation, please consult with a network manager.

▼ UPnP

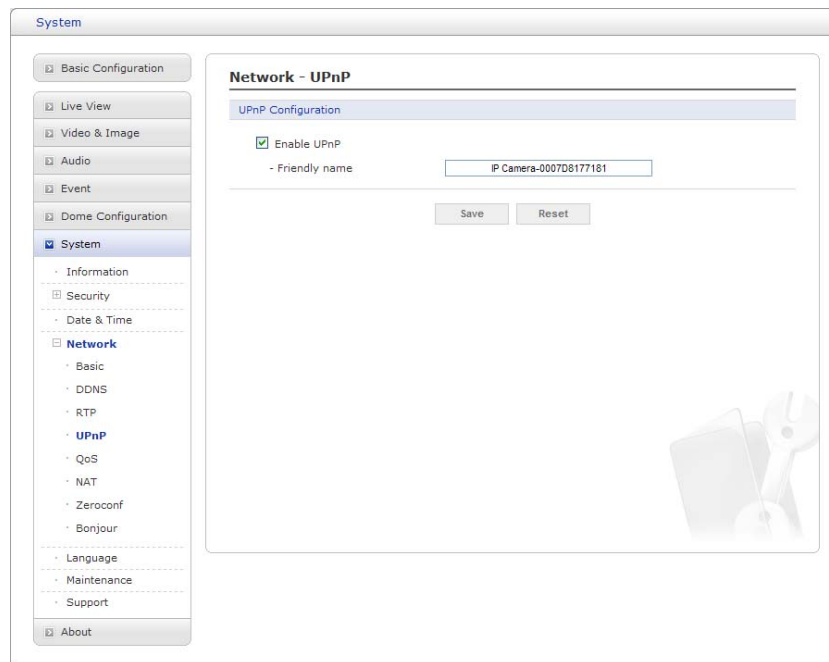

The network camera includes support for UPnP™. UPnP is enabled by default, and the network camera is then automatically detected by operating systems and clients that support this protocol.

NOTE: UPnP must be installed on your workstation if running Windows XP. To do this, open the Control Panel from the Start Menu and select Add/Remove Programs. Select Add/Remove Windows Components and open the Networking Services section. Click Details and then select UPnP™ as the service to add.

▼ QoS

Quality of Service (QoS) provides the means to guarantee a certain level of a specified resource to selected traffic on a network. Quality can be defined as a maintained level of bandwidth, low latency, and no packet losses.

The main benefits of a QoS-aware network are:

- The ability to prioritize traffic and thus allow critical flows to be served before flows with lesser priority.
- Greater reliability in the network, because of the control of the amount of bandwidth an application may use, and thus control over bandwidth races between applications.

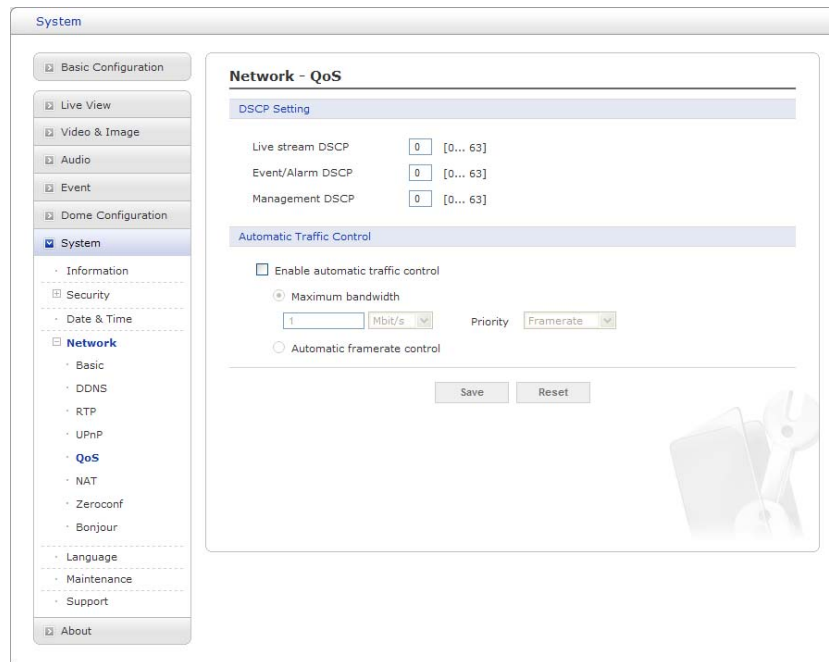

- **DSCP Settings:** For each type of network traffic supported by your network video product, enter a DSCP (Differentiated Services Code Point) value. This value is used to mark the traffic's IP header. When the marked traffic reaches a network router or switch, the DSCP value in the IP header tell the router or switch which type of treatment to apply to this type of traffic, for example, how much bandwidth to reserve for it.

NOTE: DSCP values can be entered in decimal or hex form, but saved values are always shown in decimal.

The following types of traffic are marked:

- **Live Stream DSCP**
- **Event/Alarm DSCP**
- **Management DSCP**
- **Automatic Traffic Control:** Set a limitation on user network resources by designating the maximum bandwidth. Check to enable automatic traffic control.
 - **Maximum bandwidth:** In case of sharing other network programs or equipment, it is possible to set a limitation on the maximum bandwidth in the unit of Mbit/s or Kbit/s.
 - **Automatic frame rate:** Selected if not influenced by a network-related program or equipment without a limitation on the network bandwidth.

▼ NAT

A broadband router allows devices on a private network (LAN) to share a single connection to the Internet. This is done by forwarding network traffic from the private network to the “outside,” that is, the Internet. Security on the private network (LAN) is increased since most broadband routers are pre-configured to stop attempts to access the private network (LAN) from the public network/Internet.

Use NAT Traversal when your network cameras are located on an intranet (LAN) and you wish to make it available from the other (WAN) side of a NAT router. With NAT traversal properly configured, all HTTP traffic to an external HTTP port in the NAT router is forwarded to the network camera.

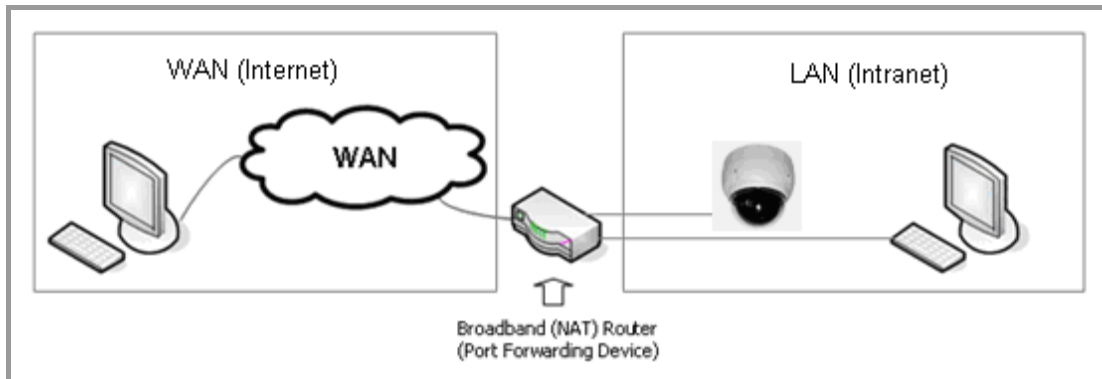

NOTES:

1. For NAT traversal to work, this must be supported by the broadband router.
2. The broadband router is known by many different names: “NAT router,” “Network router,” “Internet Gateway,” “Broadband sharing device” or “Home firewall” but the essential purpose of the device is the same.

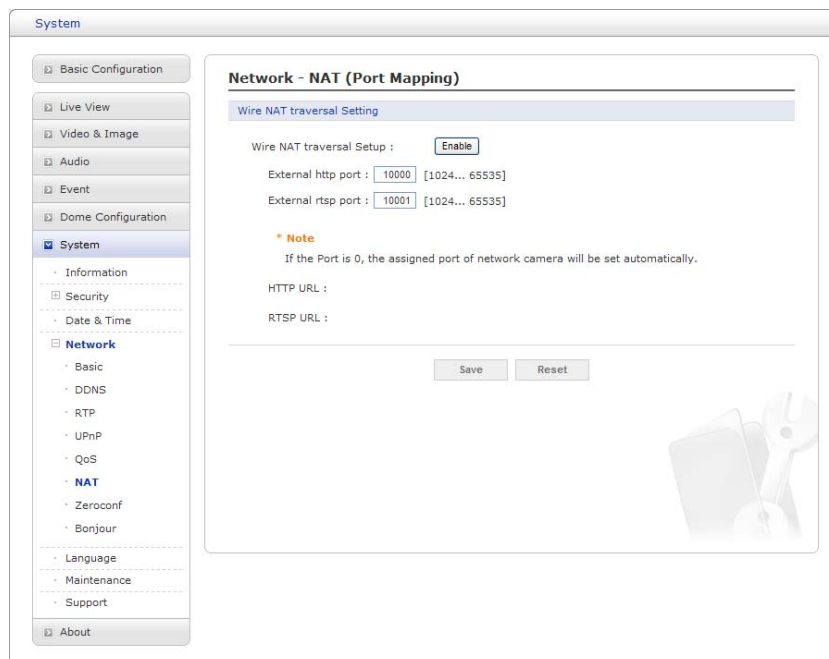

▼ Zeroconfig

Zeroconfig allows the network camera to create and assign the IP address for network cameras and connect to a network automatically.

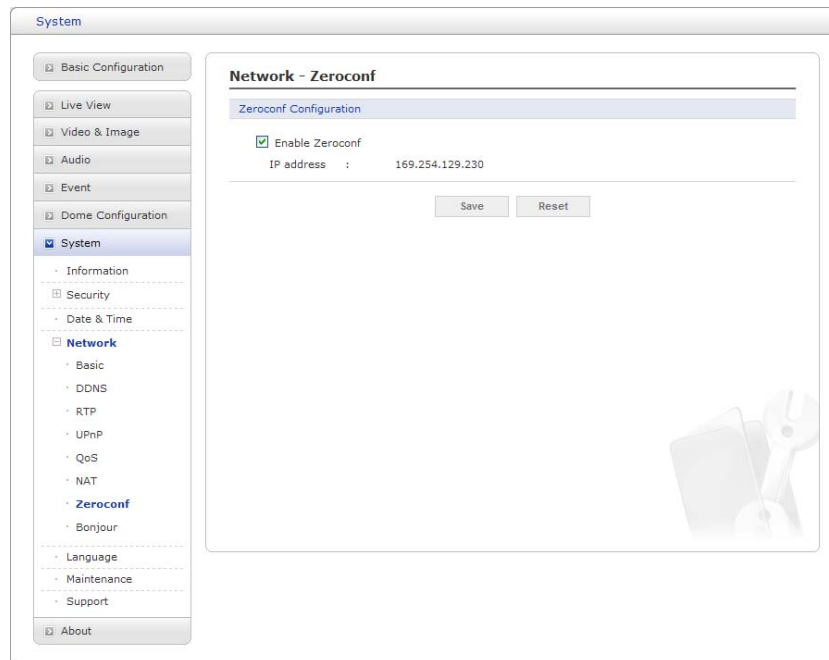

Zero configuration networking (zeroconf) is a set of techniques that automatically creates a usable [Internet Protocol](#) (IP) network without manual operator intervention or special configuration servers.

Zero configuration networking allows devices such as computers and printers to connect to a network automatically. Without zeroconf, a network administrator must set up services, such as [Dynamic Host Configuration Protocol](#) (DHCP) and [Domain Name System](#) (DNS), or configure each computer's network settings manually, which may be difficult and time-consuming.

Zeroconf is built on three core technologies:

- Assignment of numeric network addresses for networked devices ([link-local address](#) auto configuration)
- Automatic resolution and distribution of computer [hostnames](#) (multicast DNS)
- Automatic location of network services, such as printing devices through DNS [service discovery](#).

▼ Bonjour

The network camera includes support for Bonjour. When enabled, the network camera is automatically detected by operating systems and clients that support this protocol.

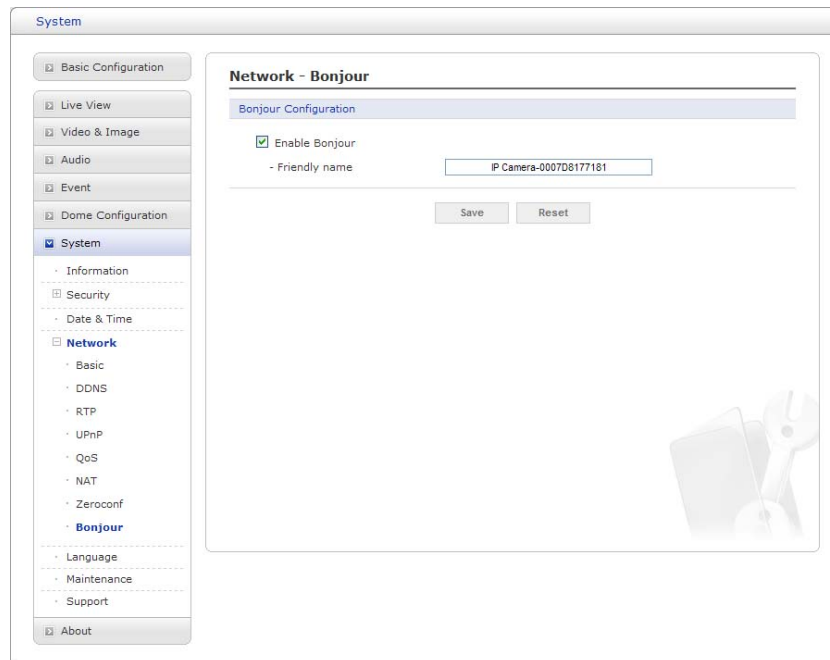

NOTE: Bonjour - Also known as zero-configuration networking, Bonjour enables devices to automatically discover each other on a network, without having to enter IP addresses or configure DNS servers. Bonjour is a trademark of Apple Computer, Inc.

5) Language

Select the desired language.

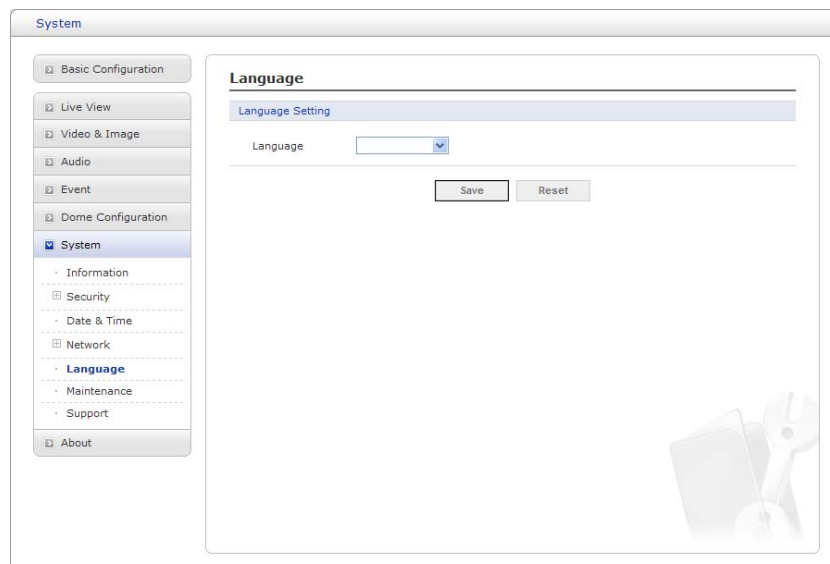

6) Maintenance

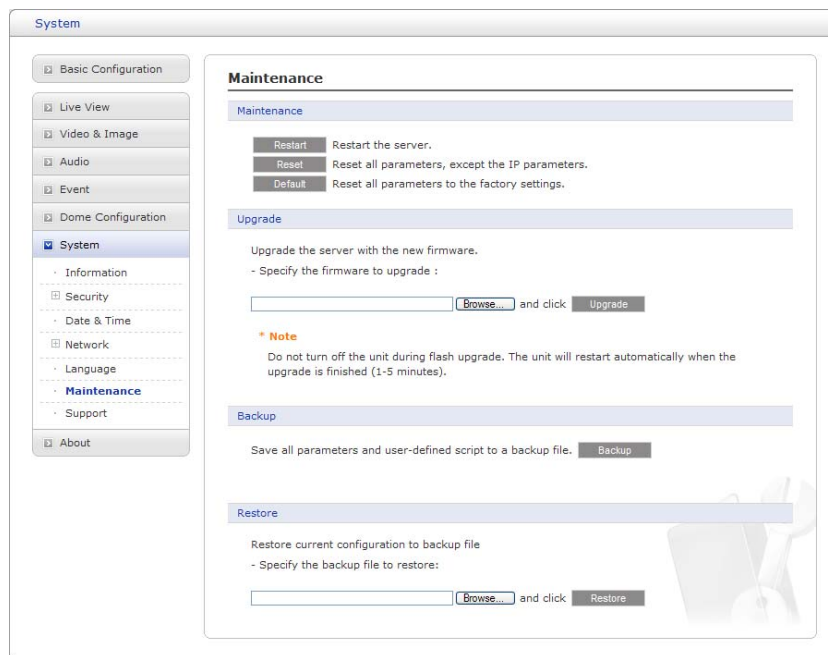

- **Maintenance:**

- **Restart:** The unit is restarted without changing any of the settings. Use this method if the unit is not behaving as expected.

- **Reset:** The unit is restarted and most current settings are reset to factory default values. The settings that are not affected are:

- * **the boot protocol (DHCP or static)**

- * **the static IP address**

- * **the default router**

- * **the subnet mask**

- * **the system time**

- **Default:** The **Default** button should be used with caution. Pressing this will return all of the network camera's settings to the factory default values (including the IP address).

- **Update:** Upgrade your camera by importing an upgrade file and pressing the **Upgrade** button. During the upgrade, do not turn off the power of the network camera. Wait at least five minutes and then try to access the camera again.

- **Backup:**

- Save the setting values that users have entered to the network camera to a user PC.

- **Restore:** Import and apply a setting value previously saved to a user PC.

NOTE: Backup and Restore can only be used on the same unit running the same firmware. This feature is not intended for multi-configurations or for firmware upgrades.

7) Support

The support page provides valuable information on troubleshooting and contact information, should you require technical assistance.

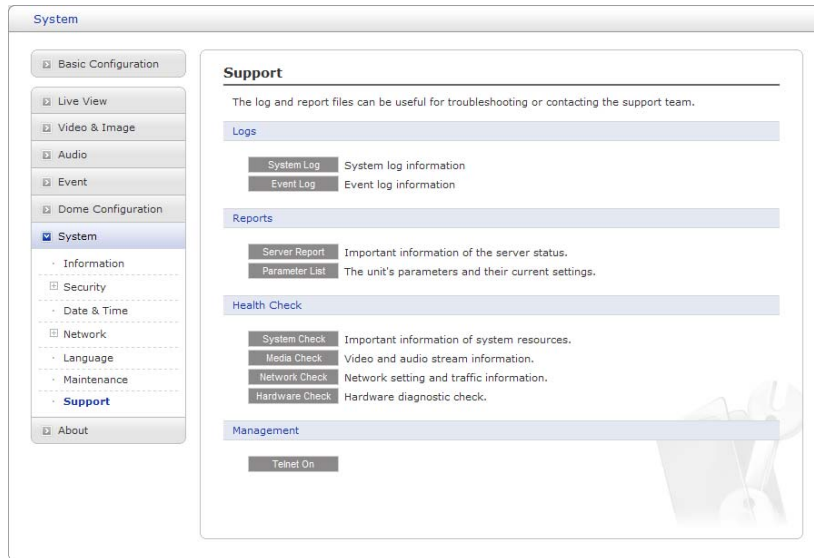

- **Logs:** The network camera supports system and event log information. Click the **System Log** button to get the system log data or the **Event Log** button to get information on events.
- **Reports:**
 - **Server Report:** Click the **Server Report** button to get the important information about the server's status; this should always be included when requesting support.
 - **Parameter List:** Click the **Parameter List** button to see the unit's parameters and their current settings.
- **Health Check:**
 - **System Check:** Click the **System Check** button to get the important information about the camera's system resources. You can see the pop-up window below.

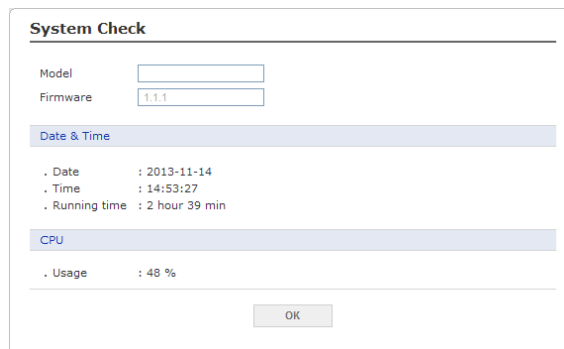

- **Media Check:** Click the **Media Check** button to get the information about the camera's video and audio stream. You can see the pop-up window below.

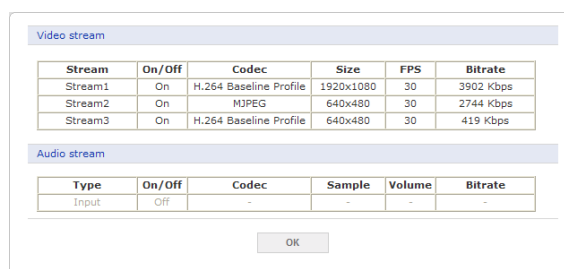

- **Networks Check:** Click the **Network Check** button to get the information about the camera's network setting and traffic. You can see the pop-up window below.

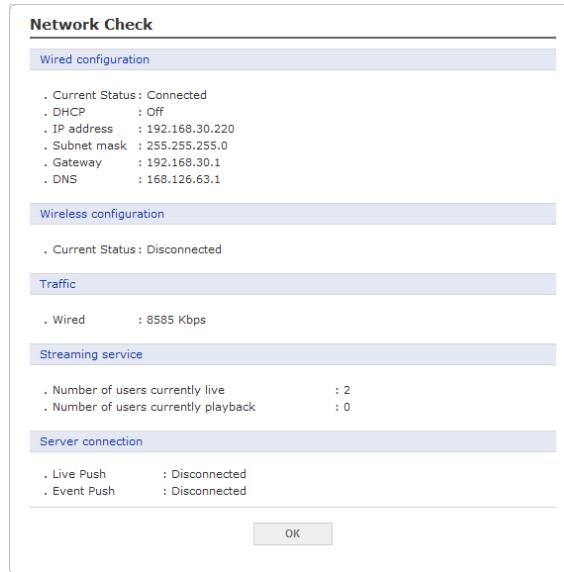

- **Hardware Check:** Click the **Hardware Check** button to diagnose the camera's hardware like video.

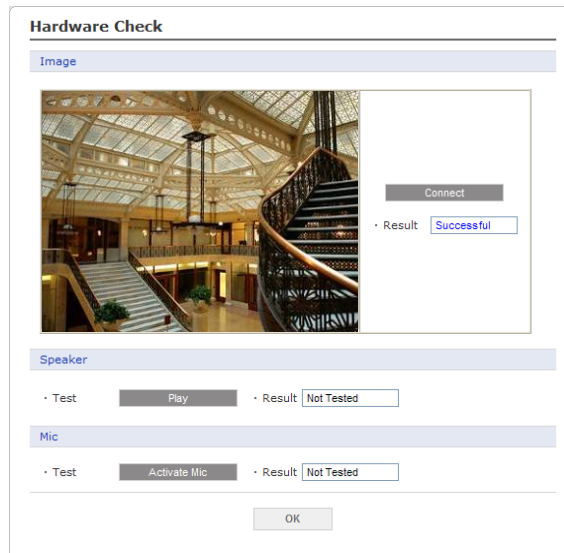

3.6 Help

The Help information window will be provided as a popup window so that users can open and read it without needing to log-in. It will offer a description of the setting and Help page so that users can manipulate the network camera without a reference to the manual.

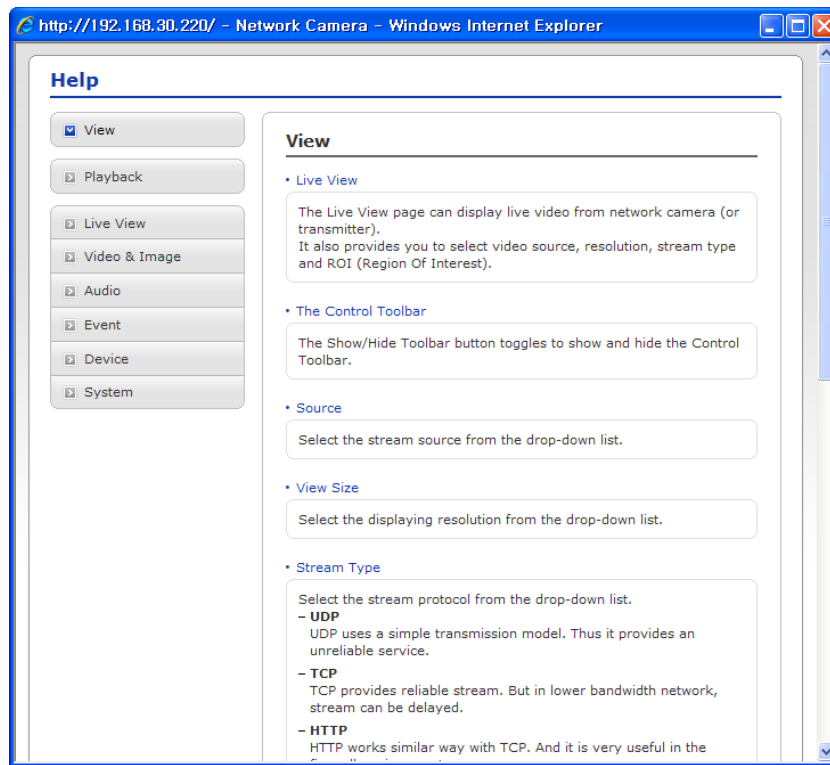

3.7 Resetting to the factory default settings

To reset the network camera to the original factory settings, go to the Setup > System > Maintenance web page (described in "3.5.7 System > Maintenance" of User's Manual) or use the **Reset** button on the network camera, as described below:

- **Using the Reset button:**

Follow the instructions below to reset the network camera to the factory default settings using the Reset button.

1. Switch off the network camera by disconnecting the power adapter.
2. Press and hold the Reset button (SW1) on the board with your finger while reconnecting the power.
3. Keep the Reset button (SW1) pressed for about 2 seconds.
4. Release the Reset button (SW1).
5. The network camera resets to factory defaults and restarts after completing the factory reset.

CAUTION: When performing a Factory Reset, you will lose any settings that have been saved.
(Default IP 192.168.30.220)

4. Appendix

4.1 Troubleshooting

Troubleshooting if problems occur, verify the installation of the network camera with the instructions in this manual and with other operating equipment. Isolate the problem to the specific piece of equipment in the system and refer to the equipment manual for further information.

Problems/Symptoms	Possible Causes or Corrective Actions
The camera cannot be accessed by some clients.	If using a proxy server, try disabling the proxy setting in your browser. Check all cabling and connectors.
The camera works locally, but not externally.	Check if there are firewall settings that need to be adjusted. Check if there are router settings that need to be configured.
Poor or intermittent network connection.	If using a network switch, check that the port on that device uses the same setting for the network connection type (speed/duplex).
The camera cannot be accessed via a host name.	Check that the host name and DNS server settings are correct.
Not possible to log in.	When HTTPS is enabled, ensure that the correct protocol (HTTP or HTTPS) is used. When attempting to log in, you may need to manually type in http or https in the browser's address bar.
No image using Refresh and/or slow updating of images.	If images are very complex, try limiting the number of clients accessing the camera.
Images only shown in black & white.	Check the Video & Image setting.
Blurred images.	Refocus the camera.
Poor image quality.	Increased lighting can often improve image quality. Check that there is sufficient lighting at the monitored location. Check all image and lighting settings.
Rolling dark bands or flickering in image.	Try adjusting the Exposure Control setting under AE and AWB part.
H.264 not displayed in the client.	Check that the correct network interface is selected in the Video & Image/Stream.
Multicast H.264 not displayed in the client.	Check with your network administrator that the multicast addresses used by the camera are valid for your network. Check that the Enable multicast checkbox are enabled in the System/Network/RTP tab. Checks with your network administrator to see if there is a firewall preventing viewing.
Multicast H.264 only accessible by local clients.	Check if your router supports multicasting, or if the router settings between the client and the server need to be configured. The TTL value may need to be increased.
Color saturation is different in H.264 and Motion JPEG.	Modify the settings for your graphics adapter. Please see the adapter's documentation for more information.

4.2 Alarm Connection

The following connection diagram gives an example of how to connect a network camera.

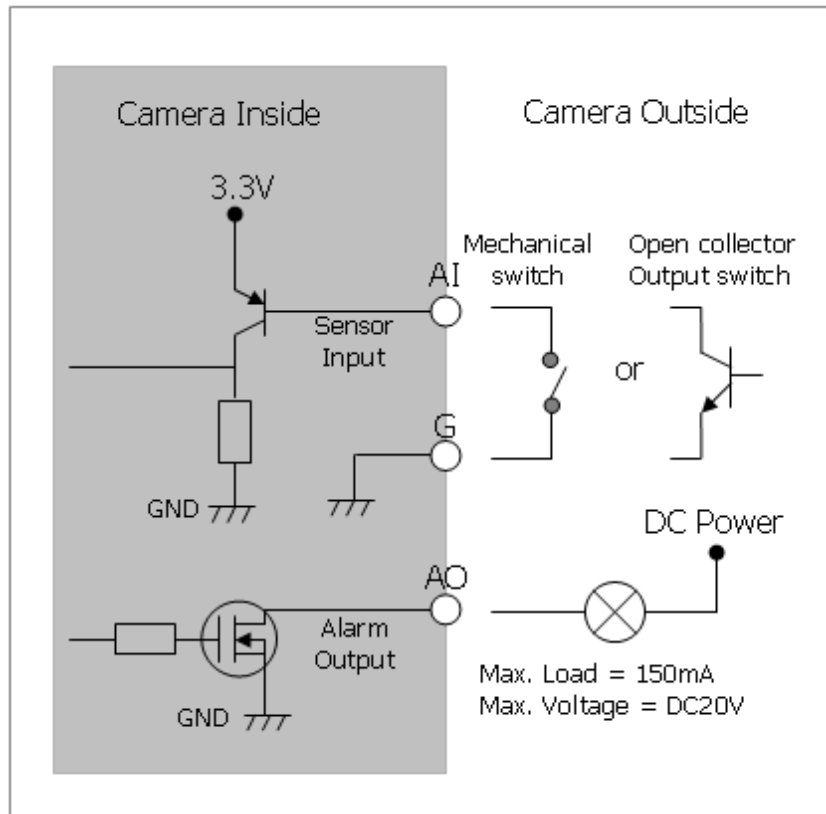

4.3 Preventive Maintenance

Preventive maintenance allows detection and correction of minor that faults before they become serious and cause equipment failure.

Every three-month, perform the following maintenance.

1. Inspect all connection cables for deterioration or other damage.
2. Clean components with a clean damp cloth.
3. Verify that all the mounting hardware is secure.

4.4 Product Specification

12x Full-HD Mini-PTZ NETWORK CAMERA

MODEL	12x
IMAGE	
Image Sensor	1/2.8" SONY Exmor CMOS
Optical/Digital Zoom	12x A/F Optical Zoom, 16x Digital Zoom
Scanning Mode	Progressive Scan
Min. Illumination	Color: 0.5Lux, B/W: 0.1Lux
AE/AWB	Yes
DNR	Yes
D&N	True D&N (IR-cut filter)
WDR	Yes
DIS	Yes
BLC	Yes
VIDEO	
Progressive Encoding	Yes
Compression	H.264 (BP/MP/HP), MJPEG
Resolution Supported	1920 x 1080p
Max. Frame Rate	1080p@60/50fps, 1080p@30/25fps
Multiple Streaming	Triple Stream (2x H.264 and 1x MJPEG)
IN/OUT	
Audio In/Out	In x 1 / Out x 1 (G.711)
Alarm In/Out	In x 1 / Out x 1
RS485	RS485
Ethernet	10/100Mbps
FEATURE	
Motion Detection	Yes
Event Buffering (Pre & Post)	Yes
Privacy Masking	Yes
PrVA (Pre-recorded Voice Alert)	Yes (3 files)
Video Analytics	Yes
Cross Web Browser	Yes
FTP Image Upload	Yes
ONVIF Certificate	Yes (Profile S)
SYSTEM	
Network Time Sync	Yes
Zero Configuration	Yes
Security	Password Protection, IP Filtering, HTTPS, SSL

NETWORK	
Max. Connections	10
Protocols	IPv4/IPv6, Manual, TCP/IP, UDP, HTTP, RTP, RTSP, NTP, DHCP, SMTP, DDNS, HTTPS, RTCP, FTP, Bonjour
NAS Support	Yes
JPEG push	Yes
DDNS	Yes
Remote Client	Web browser, SmartManager, NCTitanium
Installation Tool	SmartManager, NCTitanium
MISCELLANEOUS	
Weatherproof	IP66
PoE	802.3af Class 3
Power	PoE, 12VDC, 24VAC \pm 10%
Power (with Heater)	24VAC \pm 10%
Power Consumption	250mA (12W) @ PoE, 1.0A (12W) @ 12VDC or 24VAC
Power Consumption (with Heater)	1.5A (22W) @ 24VAC \pm 10%
Operating Temperature	-10°C ~ 50°C (14°F to 122°F)
Operating Temperature (with Heater)	-30°C ~ 50°C (-22°F to 122°F)
Operating Humidity	0 ~ 90% RH
External Dimension	See dimension drawing
Weight	Approx. 1.6 kg for dome
PTZ FUNCTION	
Pan Range	360° Endless
Pan Speed	Preset: Max. 380°/sec, Manual: Max. 380°/sec
Tilt Range	180° (0° ~ 180°)
Tilt Speed	Preset: Max. 380°/sec, Manual: Max. 300°/sec
Preset	240

* Specifications are subject to change without notice *

UNIT : mm

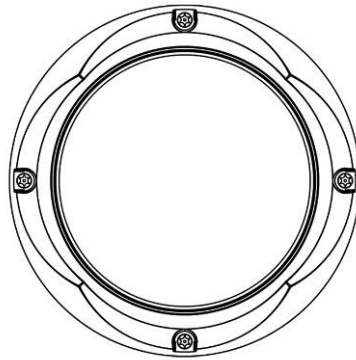

TOP VIEW

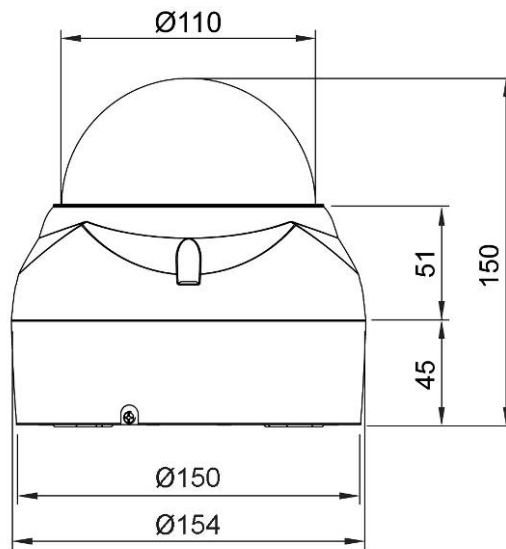

FRONT VIEW

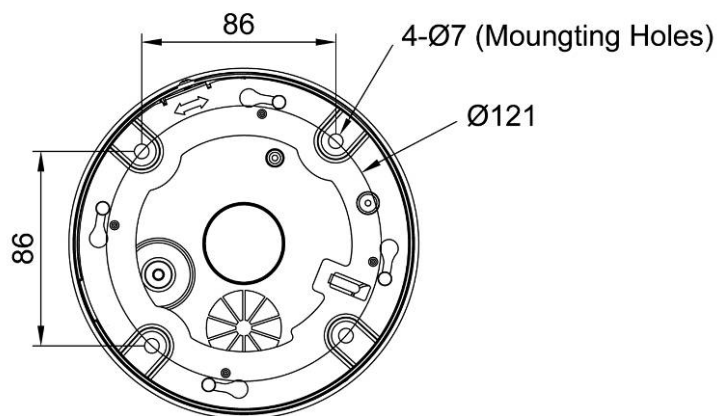

BOTTOM VIEW

Figure – Dimension

4.5 System Requirement for Web Browser

- **Operating System:** Microsoft Windows OS Series
- **CPU:** Intel Core 2 Duo 2Ghz or higher, 1GB RAM or more, 10GB free disk or higher
- **VGA:** AGP, Video RAM 32MB or higher (1024x768, 24bpp or higher)

4.6 General Performance Considerations

When setting up your system, it is important to consider how various settings and situations will affect performance. Some factors affect the amount of bandwidth (the bit rate) required, others can affect the frame rate, and some affect both. If the load on the CPU reaches its maximum, this will also affect the frame rate.

The following factors are among the most important to consider:

- High image resolutions and/or lower compression levels (or high bitrates) result in larger images. Frame rate and Bandwidth affected.
- Accessing both Motion JPEG and H.264 video streams simultaneously. Frame rate and bandwidth affected.
- Heavy network utilization due to poor infrastructure. Frame rate and Bandwidth affected.
- Heavy network utilization via wireless router due to poor infrastructure. Frame rate and bandwidth affected.
- Viewing on poorly performing client PCs lowers perceived performance. Frame rate affected.



**REVO ELITE HD
12x Full-HD Mini-PTZ NETWORK CAMERA**