

#### 4. Adjust 3-Axis Bracket

Adjust the bracket while checking the view angle from the monitor. Loosen the bracket lock knob by turning counterclockwise, after adjusting the 3-Axis bracket (X-Y-Z Axis) to get the desired viewing angle, tighten the lock knob by turning it clockwise.

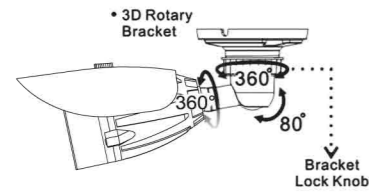

#### 5. Install Sunshield

To install the sunshield, please follow the instruction shown below:

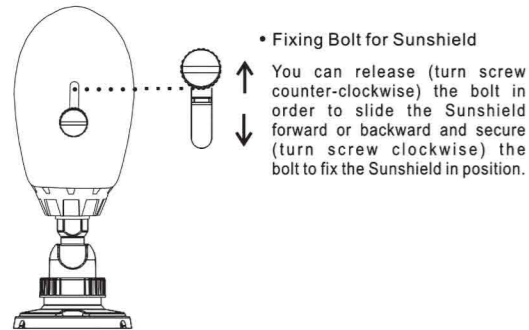

You can release (turn screw counter-clockwise) the bolt in order to slide the Sunshield forward or backward and secure (turn screw clockwise) the bolt to fix the Sunshield in position.

### 6. SPECIFICATIONS

According to the camera purchased, select and refer to the appropriate specification below:

Model No.	RCBS30-3	RCBS12-3
Image Device	1/3" Color Image Sensor	
Picture Elements	NTSC: 960x480	
Resolution	700TVL	
Min Illumination	0 Lux (IR On)	
S/N Ratio	More than 48dB	
Electronic Shutter	NTSC: 1/60S~1/100,000S	
Gain Control	Auto	
White Balance	Auto	
Gamma	0.45	
Lens Furnished	Board Lens	
Sync System	Internal	
Video Output	1Vp-p/ 75 Ohms	
Power Supply	DC 12V±10%	
Power Consumption	IR LED OFF	90mA max.
	IR LED ON	300 mA max. / 180 mA max.
<b>Infrared Illuminator Module</b>		
Infrared Luminary	30IR LED	12IR LED
Wavelength	850nm	
Illuminant Distance	31m	15m
IR filter	Automatic IR Cut Filter Removal	
Power Supply	DC 12V±10%	
Power Consumption	4W	3W
<b>System Device</b>		
Operating Temp.	-10°C to 50°C (14°F to 122°F)	
Construction	Aluminum Case	
Waterproofing Criterion	IP 66	
Dimensions	φ 55x85 (L) mm (Body only)	

(Note: Design and specifications are subject to change without prior notice.)

# MEMO



## Indoor / Outdoor IR Night Vision Camera

### Instruction Manual

Thank you for purchasing our product. Before installing this camera, please read this instruction manual carefully to ensure proper use.

### 1. Safety Precautions

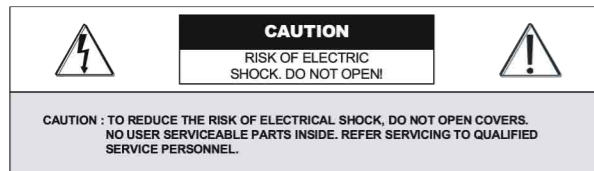

Disposal of Old Electrical & Electronic Equipment (Applicable in the European Union and other European countries with separate collection systems).

Although the camera is provided with tempered glass, please avoid all direct contact to eliminate contamination, and use cotton balls dipped in cleaning alcohol to clean the window.

### 2. Description

This Infrared Illuminator camera uses a highly sensitive 1/3" interline transfer color image sensor, which provides extremely long life and high reliability. This camera offers excellent image quality and functions with low lag and high burn resistance, and is not subject to distortions from magnetic fields.

Highly resistant to shock and vibration and easy to install, this camera is an excellent choice for your CCTV system.

### 3. Feature

- ◆ Super high resolution indoor/outdoor camera with a built-in high performance illuminator module.
- ◆ Total pixels of sensor: NTSC=480Kpixels.
- ◆ High sensitivity, low smear, excellent anti-blooming, and high S/N ratio.
- ◆ Supports functions: Auto Electronic Shutter (AES), Auto Gain Control (AGC), Auto White Balance (AWB), Back Light Compensation (BLC), and Flickerless mode (FL).
- ◆ Built-in board Lens and furnished with mounting bracket.
- ◆ Automatic IR Cut Filter Removal.
- ◆ Low DC power consumption.
- ◆ Dual Window Structure.
- ◆ 3-Axis Concealed Cable Bracket.
- ◆ Waterproofing criterion: IP66.

### 4. Content

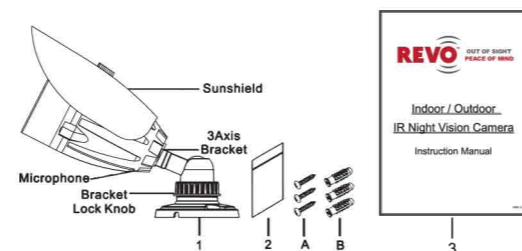

Item	Name of Part	Quantity
1	Infrared Camera	1
	Bag	1
2	A Fix Retaining Screw for Bracket	3
	B Anchor	3
3	Instruction Manual	1

### 5. Installation & Operation

#### 1. Install Preparation

Drill a hole in the wall if wire needs to go through the wall.

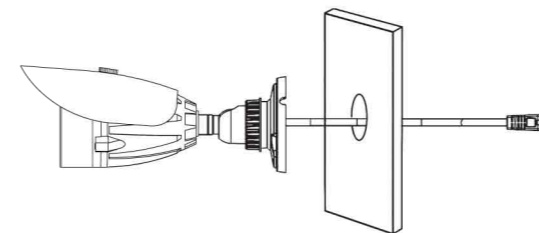

Or cable can go through the camera base slots, If the cable does not need to go through walls.

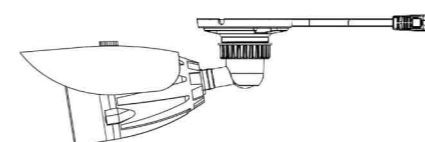

#### 2. Install Camera

Use the 3 screws provided to attach the camera and bracket to the ceiling, surface or wall.

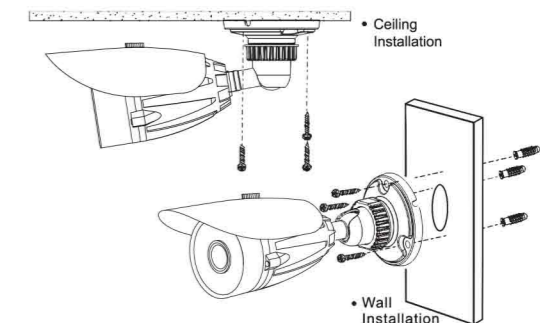

#### 3. Wiring Instructions

Connect the RJ-12 end of the camera cable to the extension cable; connect the extension cable to the DVR.

